



# Specific Design Technical Guide

to the specification, installation and maintenance of Hinuera Natural Stone.

July 2022 | Version 9



State Highway 29, Hinuera | 0800 HINUERA (0800 446 8372)

[hinuera.co.nz](http://hinuera.co.nz)







This guide has been designed to assist the reader in achieving successful specification and use of Hinuera Natural Stone. This document draws upon and collates the relevant information from over 100 years of Hinuera Stone use as a building component.

While Hinuera Natural Stone is used in ways that are very similar to other common building materials, the fact that it is a natural material makes it unique. This means special attention to some details when specifying and planning its use on a project.

While the best knowledge has been incorporated into this guide, it is equally important to involve design and building specialists such as architects, engineers, builders, and experienced installers, together with specialist providers of other components and services, such as adhesives, sealers, and maintenance.

In addition to this guide, Hinuera Natural Stone technical specialists are available to assist if more specific advice is needed.

Under the Building Code, E2/AS1 Masonry (2011) is only applicable to concrete and clay bricks, stone product such as Hinuera, require 'Specific Design', this document is that 'Specific Design'.

Please contact Hinuera Natural Stone to ensure that the copy of this guide you are using is the latest version.



# Contents



What is Hinuera Natural Stone .....	4	<b>5.0 Hinuera Natural Stone slips .....</b>	<b>13</b>
<b>1.0 Grades, uses and appearance .....</b>	<b>5</b>	51 General .....	13
Table 1 – grades, uses and appearance		52 Weathertightness .....	13
<b>2.0 Physical properties .....</b>	<b>5</b>	53 Substrate .....	13
Table 2 – physical properties		53.1 Over masonry or concrete	
Table 3 – product weight		53.2 Over fibre Cement sheets	
<b>3.0 Sizes</b>		53.3 Mechanical fixing of Hinuera Natural Stone slips	
3.1 Size limitations relating to production .....	6	54 Similarity to veneer claddings .....	14
3.2 Size limitations relating to site		55 Important notice .....	14
Handling and practicality .....	6	<b>6.0 Hinuera Natural Stone paving.....</b>	<b>15</b>
3.3 Typical face dimensions .....	6	6.1 Moisture barrier .....	15
3.4 Typical thicknesses .....	6	6.2 Mortar fixing .....	15
3.5 Product tolerances .....	6	6.3 Tile cement adhesive .....	15
<b>4.0 Veneer cladding .....</b>	<b>7</b>	6.4 Joints .....	15
4.1 Related documents .....	7	6.5 Maintenance of Hinuera Natural Stone Paving .....	15
4.2 Foundations .....	7	<b>Important notice .....</b>	<b>16</b>
4.3 Timber framing .....	7	<b>Appendices</b>	
4.4 Mortar .....	7	Appendix 1 Associated products and services .....	17
4.5 Mortar joints .....	8	Appendix 2 Designer’s checklist .....	18
4.6 Stone installer.....	8	Appendix 3 Builder’s/Supervisor’s checklist .....	19
4.7 General laying specifications.....	8	Appendix 4 Stone mason’s checklist.....	20
4.8 Ties (heavy duty).....	9	Appendix 5 Drawings .....	21
4.9 Veneer cavity .....	9	Appendix 6 Producer statement design (PS1).....	29
4.10 Weep holes and ventilation.....	9	Appendix 7 Order form – sample.....	30
4.11 Window and door openings .....	10	Appendix 8 Alternative fixing method .....	31
4.12 Window sills.....	10	Appendix 9 PASS (Product Assurance Supplier Statement) .....	33
4.13 Supporting Hinuera Natural Stone over openings (lintels) .....	10		
Table 4 – lintel bar sizes .....	10		
4.14 Flashings.....	10		
4.15 Penetrations .....	11		
4.16 Vermin proofing .....	11		
4.17 Height limitations for Hinuera Natural Stone Veneers .....	11		
4.18 Control joints.....	12		
4.19 Sealing Hinuera Natural Stone Veneer cladding .....	12		
4.20 Maintenance of Hinuera Natural Stone Veneer cladding .....	12		

# What is Hinuera Natural Stone



Hinuera Natural Stone is cut from a naturally occurring Ignimbrite deposit, which is a volcanic rock.

As the strength and hardness of Hinuera Natural Stone varies it is categorised into five grades. These different grades are also categorised by appearance.

**Right:** Hinuera Natural Stone quarry cross section diagram.

## Where is it used?

Hinuera Natural Stone is suitable for commercial, institutional and residential building applications as well as for shaping into decorative profiles and sculptures.

Uses of the various grades include cladding, decorative facings, and residential paving.

## Standards and Building Code Compliance

Hinuera Natural Stone meets or exceeds the requirements of 'natural stone' as defined in NZS 4210 Masonry Construction: Materials and Workmanship. The design, detailing and construction aspects of Hinuera Natural Stone veneer cladding are in most respects the same as clay or masonry brick veneer.

Reference to NZS 3604 Timber Framed Buildings and NZS 4210 should be made during the design and construction phases of Hinuera Natural Stone veneer clad timber framed buildings.

Should there be a difference in guidance given in this document compared to information provided in the appropriate New Zealand Standards, this 'Specific Design' which is compliant with the 'Performance Clauses' of the Building Code' B1, B2 and E2, takes precedence.



# 1.0 Grades, uses and appearance



Hinuera Natural Stone can be supplied with either a sawn or split face, giving a choice of two fundamentally different surface finishes.

As a natural material, the inherent range of colour and texture within any one sample is broad. Hinuera Natural Stone can vary from plain stone to having many natural markings throughout.

Kiln firing changes the colour of the stone into Golden Haze and highlights the markings. Kiln firing may also create micro-cracks, however these do not affect the performance of the stone when laid

or affect its suitability for the uses defined in Table 1.

It should be noted that the natural variations in the appearance of Hinuera Natural Stone are not defects or grounds for replacement.

A wide range of laying options can be supplied eg. random lengths, random heights and mixed grades.

The stone grade selected needs to be appropriate for its end use (see Table 1 below). For strength comparisons refer to Table 2.

## 2.0 Physical properties

The stone is graded by physical properties as well as composition; however, a clear distinction between the grades is often not possible. As a natural product some variation in physical properties can be expected even within grades. The following values are to be considered indicative only.

**Table 1: Grades, uses and appearance**

Uses					Grade	Texture	Colour	
Veneer cladding	Residential paving*	Window & door sills	Stair treads	Fire surrounds				
●					Ahi	Coarse grained, variable textured stone interspersed with particles of white and cream pumice of various sizes	Natural	Golden Haze
	●	●	●		Kaha	Similar in appearance to Ahi but with smaller sized hard pumice particles	Cream to Buff	Terracotta to Golden Brown
				●	Kaha Select	Similar to Awa with fine grains and water/mineral marking running through with even smaller sized pumice particles than Kaha	Cream to Grey	Terracotta to Golden Brown
	●	●	●	●	Awa Select	Very durable fine clear grain stone grade with fine pumice and water/mineral markings running throughout	Cream to Grey	Terracotta to Golden Brown
●					Awa	Fine grain clear of pumice with water/mineral markings – occasionally dark iron marks are present	Cream to Fawn	Terracotta to Golden Brown

\*Hinuera Natural Stone Awa Select grade is not recommended for use around saltwater pools.

\*Hinuera Natural Stone is not recommended for use in high traffic or commercial paving applications.

**Table 2: Physical properties**

Stone grade	Compressive strength range (mpa)	Typical density (kg/m <sup>3</sup> )	
		Saturated	Oven dry
Ahi	3.0 to 4.0	1791	1493
Ahi (hard)	4.9 to 7.2	1837	1564
Awa	3.7 to 5.6	1744	1382
Awa Select	6.6 to 12.3	1834	1568
Kaha	8.1 to 14.6	2074	1936
Kaha Select	20.5 to 21.0	2064	1881

**Table 3: Product weight (kg/m<sup>2</sup>)**

Thickness (mm)	20	25	40	60	70	90	Assumed density (kg/m <sup>3</sup> )
Ahi	38	48	76	114	133	171	1900
Awa	38	48	76	114	133	171	1900
Kaha	42	53	84	126	147	189	2100

Tested in accordance with  
AS/NZS4455 and 4456.8  
Note: density used for design should  
be for saturated stone.

# 7.0 Sizes



There are a variety of influences on the sizes of pieces of Hinuera Natural Stone that can be supplied – some stemming from production limitations, and some more related to the practicalities of the end use.

## 3.1 Size limitations relating to production

**Quarried block size:** the maximum dimension of any piece is approximately 1600mm.

**Saw size:** the maximum width of a cut face cannot be larger than 800mm. Thus, the second largest of the three dimensions of a given piece cannot be greater than 800mm.

**Golden Haze size:** the maximum dimensions of the largest face cannot exceed 500 x 500mm.

**Kiln conditions:** the porosity of Hinuera Natural Stone is such that it may restrict moisture escaping during kiln firing. Larger pieces of stone can therefore be prone to fracture as water turns to steam inside the stone. It is desirable to keep cross sections small to minimise this occurrence. Designers should discuss their requirements with a Hinuera Natural Stone representative.

## 3.2 Size limitations relating to site handling and practicality

Paving slabs with their greatest dimension (length) less than 600mm are normally supplied 20mm thick.

Paving slabs with their greatest dimension (length) more than 600mm are normally supplied 25mm thick.

Slabs 600mm long can be supplied at either thickness.

## 3.3 Typical face dimensions

Paving is available in almost any size, within the limitations stated above. At the time of printing, standard sizes are 380 x 380mm, and 380 x 770mm. Standard sizes will vary over time in accordance with current fashion.

Splitstone veneer claddings are normally supplied in the following heights: 60mm, 95mm, 130mm and 200mm.

Sawnstone claddings are supplied in standard sizes of 600 x 300mm, 390 x 190mm and 270 x 130mm. Custom sizes are available on request.

The minimum recommended height of a piece of Hinuera Natural Stone is 60mm.

## 3.4 Typical thickness

Thickness (mm)	20	25	40	60	70	90
Veneer cladding					●	●
Slips		●	●			
Door and window sills				●		
Stair treads			●	●		
Paving	●	●				

### Non-standard sizing and dimensions:

On some occasions or projects where custom cutting is required, the stone may be cut down to 50mm. Additional brick ties or adhesives may be required and used by the installer to compensate for this so as to not affect the structural integrity.

## 3.5 Product tolerances

For Natural claddings and paving, acceptable tolerances are +/- 2mm. For Golden Haze claddings and paving, tolerances are +/- 3mm.

## 8.0

# Veneer Cladding



### 4.1 Related documents

Hinuera Natural Stone veneer claddings must be designed and constructed in accordance with this 'Specific Design'. Should an aspect of your design not be covered in this document then design and construction should be in accordance with the following documents:

E2/AS1 Masonry  
NZS 3604: Timber Framed Buildings  
NZS 4229: Masonry Buildings not requiring Specific Design  
NZS 4210: Masonry construction: Materials and Workmanship  
AS/NZS 4455: Masonry Units and Segmental Pavers  
AS/NZS 4456: Masonry Units and Segmental Pavers – Methods of Test  
NZS 3117: Pigments for Portland Cement  
AS/NZS 2699: Components for Masonry Construction Additional information: John Oliver's Brick Book 2014

### 4.2 Foundations

Hinuera Natural Stone veneer cladding should be supported by either a thickened slab edge footing or a foundation wall.

Details shown in Appendix 5 are based on NZS 3604 (refer to figure 1).

When Splitstone is being used it is recommended that the foundation recess be no less than 150mm wide to accommodate the additional overall width of the undulating stone without compromising cavity space.

It is important that the ledge, upon which the first course of Hinuera Natural Stone is laid, is a minimum of 50mm below the finished floor level. Hinuera Natural Stone recommend 100mm for additional weather proofing.

The finished height of the floor slab must be a minimum of 100mm above the external ground height for areas that are permanently paved and a minimum of 150mm for unsealed ground.

The external ground level must be 25mm below the base of the veneer and slope away from the structure to direct water away from the building (refer to figure 1).

### 4.3 Timber framing

All timber framing shall comply with durability requirements of NZS 3602 and structural requirements of NZS 3604. Where specific engineering design has been used, the structure must conform to the building consent documents as specified by the design engineer.

A rigid or non-rigid wall cladding underlay or sheathing shall be provided behind the veneer, in accordance with Section 11.4 of NZS 3604, but must not infringe the 40mm minimum cavity.

Gable ends must be framed with studs at 400mm or 600mm centres, or the end truss designed to provide equivalent support. Trusses must be adequately braced.

#### Air pressure drops

In order to comply with E2/AS1, Clause 9.1.4, where walls are not lined, such as attic and roof spaces at gable ends and areas of a similar construction, they must be fitted with an effective air barrier, fixed to the framing prior to the stone veneer being installed. In situations like this consideration should be given to lining the entire wall concerned in order to maintain a uniform minimum 40mm cavity.

### 4.4 Mortar

Hinuera Natural Stone strongly recommends the use of a bagged trade mortar, for its consistency in strength and colour, low salt content and minimal on-site wastage. Dricon can provide a range of colours including custom colours for Hinuera Natural Stone.

Site-mixed mortar shall be manufactured from cement, sand, hydrated lime and clean water.

Hydrated lime may be omitted providing all performance requirements of NZS 4210 are achieved.

Mortar may incorporate plasticising, accelerating, retarding and/or air-entraining admixtures complying with the relevant standards in NZS 4210 and used in the proportions specified by the manufacturer.



Mortar is required to have a bond strength of 200kPa. In order to achieve this, a mix of 4 sand to 1 cement by volume is required. The mix is to be as wet as practically possible. Further, it is recommended that CEMIX Multi-bond be added to the mix in the proportion of 100mls/mix. If a bagged mortar is being used, then 40mls/bag.

Mortar which is to be coloured, may incorporate up to 6% powder oxide by weight. We recommend Bayer Oxides be used.

**Important note:** due to the possibility of high levels of minerals being present in ground-water (eg. iron, manganese etc.), which can induce surface staining of the stone, it is recommended that only town-supply or rain water be used for mortar-gauging and clean-up processes.

## 4.5 Mortar joints

All stone shall be fully bedded in mortar as per NZS 4210. If a stone is moved prior to the mortar being fully cured and the bond is broken, the stone must be re-laid using fresh mortar.

All joints (both horizontal and vertical) shall be +/- 1mm off a determined thickness. The minimum a joint may be is 7mm and the maximum 13mm. ALL joints are to be consistent in thickness.

It is recommended that at least ten stones from different pallets be measured and used as an average for joint calculations.

Some designers specify thinner joints between the Hinuera Natural Stone blocks than the standard 10mm. Hinuera Natural Stone believes that joints should be no less than 6mm. To achieve this 6mm joint, ties must be recessed into the Hinuera Natural Stone and fixed with a stainless steel pin. Tie spacing must comply with NZS 4210. Refer also 4.8.

The bottom mortar joint may be up to 20mm in thickness to accommodate variations in the foundation.

Mortar joints may be raked to maximum depth of 6mm.

All mortar joints must be compacted and surface-sealed by tooling them smooth.

## 4.6 Stone installer

Stone laying is a specialised trade and only trade qualified bricklayers or stone masons should be engaged to install Hinuera Stone products. For a full list of installers, please email [diane.baker@hinuera.co.nz](mailto:diane.baker@hinuera.co.nz).

## 4.7 General laying specification

### 🔪 Prior to commencing work

Check that the Hinuera Natural Stone is as per order and in good usable condition. Refer to check lists.

Store the stone in a safe manner and protect it from being stained by other trades working on the site.

Check that a 40mm minimum cavity can be achieved. Recommended that a 50mm cavity be used.

The vertical concrete up stand between the finished floor level and the concrete ledge upon which the Hinuera Natural Stone sits, must be sealed using two coats of bitumen emulsion or a polythene DPC, to prevent possible moisture ingress through the side of the slab, as per NZS 3604.

Check that all window and door openings have been properly prepared (see section 4.11), support bars and flashings installed.

**Important note:** any issues relating to the quality of the Hinuera Natural Stone product must be raised and addressed prior to the product being laid. Hinuera Natural Stone's policy is 'a stone laid, is a stone accepted'.

### 🔪 Laying

Ensure the stone is clean, free from accumulated dust and thoroughly wet prior to laying, to ensure that the mortar cures properly.

### Hot weather construction

When a Hinuera masonry veneer is being constructed in an air temperature above 25 degrees celsius, or where there is a warm drying wind at lower temperatures, the following precautions must be taken.

- (1) Thoroughly wet the Hinuera Stone prior to use
- (2) Mortar shall be kept moist, protected from the elements where practical to do so, and shall not be spread on the wall so far ahead of the units being laid as to cause loss of plasticity or bond
- (3) Mortar older than 1 hour is not to be used for laying the veneer
- (4) The mortar shall be prevented from drying so rapidly that it cannot cure properly. This may be achieved by applying a very light fog spray several times during the first 24 hours after laying or by other protective measures over the same period

**Important note:** if the mortar in the finished veneer is powdery the strength of the mortar is in question. This could result in the veneer being demolished and rebuilt at the stone mason's expense.

It is recommended that washouts be provided at approx 3000mm centres around the base of the veneer plus one at each corner.

An overhang of up to 20mm is permissible when laying the first course.

The veneer must be laid level and plumb to within the tolerances specified in NZS 4210, Table 2.2.

It is important to achieve an even spread of stone colour in the finished veneer. This is best achieved by mixing and matching using several pallets to work from.

The stone veneer must be cleaned thoroughly of excess mortar as the job progresses using a clean sponge and water. However, care must be taken not to wet the stone to an extent that is incompatible with the chosen sealer.

The stones should be laid generally in stretcher bond pattern, and have a minimum overlap of 25%. It is accepted that situations do occur when Hinuera Natural Stone must be laid in a stack bond pattern or the minimum 25% overlap is difficult to achieve. When this occurs, additional ties should be installed. This situation should always be the exception and avoided wherever possible.

For random stone size patterns the following guidelines may be used:

- 2 sizes: 200mm high stone 70%; 95mm high; stone 30%.
- 3 sizes: 200mm high stone 37%; 130mm high; stone 47%; 60mm high stone 16%

These combinations have proved popular but other combinations may be used to achieve various aesthetic effects.

Traditionally, mixed grade patterns have been laid using a ratio of 70% Ahi Grade to 30% Awa Grade.

#### **⚔ Piers and returns**

No length of wall or return shall be less than 100mm measured on the external face of the veneer. If a veneer is supporting a lintel bar the minimum length shall be 230mm. In all cases, the veneer is to have a brick tie every 200mm over the height of the veneer.

#### **⚔ Protection**

It is essential that the Hinuera veneer is protected from damage due to vibration, impact or excessive weight placed on the veneer, especially during the first 7 days of the curing process. In the event that the veneer is damaged and hairline cracks appear in the veneer, the veneer is to be relayed in these areas so as to provide a good bond throughout.

As Hinuera Natural Stone is easily stained, protect the stone surface from contamination by adjacent trades.

## **4.8 Ties**

Ties shall comply with all provisions of NZS 4210. Ties must be heavy duty ties with a durability that complies with NZS 4210 Table 4.4. Note that 'Sea Spray' zones require stainless steel ties.

Ties must have an embedment length of at least half the width of veneer, with an end cover of 15mm minimum.

Ensure screws are installed to their full depth, failure to do so could result in the veneer being relayed at the expense of the stone mason.

The ties must be located at a maximum horizontal spacing of 600mm, and fixed into studs or structural members, and a maximum vertical spacing of 400mm. This equates to approximately 5 ties/m<sup>2</sup>.

At the top and bottom of all openings, vertical spacing of ties must be not more than 300mm or 2 courses, whichever is smaller.

Ties must be located not more than 300mm from the sides of openings or from an unsupported edge.

When a Hinuera Natural Stone veneer is being laid using 600mm x 300mm size stones, it is essential that supporting studs are installed at 400mm crs to ensure at least two brick ties for every stone laid. If the studs are at 600mm crs, 90x45mm noggs are to be installed on edge at 600mm crs over the height of the stud to provide additional fixing every second row.

## **4.9 Veneer cavity**

The minimum clear cavity must be 40mm and the maximum 75mm. Hinuera Natural Stone recommend a cavity designed to 50mm.

In situations where it is unavoidable to maintain a minimum cavity of 40mm, the timber framing must be protected by installing an impervious membrane (normally polyethylene plastic such as Supercourse 500) over the building wrap. This may occur at sills, half height veneers and other design situations.

When Splitstone is being installed, due to the natural undulation of the stone, it is important to take extra care to ensure that the 40mm cavity is not compromised. It is recommended that a foundation recess width of no less than 150mm be provided to accommodate splitstone.

If required, stone may overhang the foundation by 30mm in order to maintain a minimum 40mm cavity.

The cavity must be sealed off from the roof space and sub-floor space.

## **4.10 Weep holes and ventilation**

Drainage must be provided around the base of the veneer in order to achieve 1000mm<sup>2</sup> opening area per metre length of wall.

Weep holes are to be installed around the base of the veneer and across the head of opening greater than 1.0m in length. The weep holes are to be 1000 sq.mm/m of wall. Weep holes are not to exceed 12mm in width and can range in height from 50mm to 100mm.

Ventilation must be provided around the top of the Hinuera Natural Stone veneer. This may be achieved in a similar manner to that used to form the weep holes. Alternatively, leave a 5mm gap at the top between the veneer and the soffit lining. Refer to Figure 3.

Neither ventilation nor drainage may be provided by connecting the cavity to the roof or sub-floor space.

## 4.11 Window and door openings

The size and placement of window and door openings must be considered carefully at the design stage. As with all house designs, adequate lengths of wall panels are needed to provide the required bracing.

Where lintel bars are to be installed in the traditional manner, namely, spanning from one side of the opening to the other free of the frame, consideration must be given to requirements for seating of the lintel bars and a sufficient length of veneer either side of the opening provided to achieve this. (See also section 4.13).

The framing openings must be fully prepared for window installation in accordance with E2/AS1 or other specific window manufacturer's recommendations. This includes (but may not be limited to):

- Turning wrap into opening and covering the framing,
- Installing flexible flashing tapes,
- Installing sill trays

All windows and doors must be site measured prior to manufacture. In doing so, a minimum clearance of 7.5 to 10mm must be allowed for between all sides of the timber framing and the joinery liner in order to accommodate 'air seals'. Refer to E2/AS1 and the window manufacturer for installation details.

When site measuring for the joinery, allow for the joinery to cover onto or overlap the veneer by 10 to 20mm. This overlap dimension must be allowed for in the timber reveal liner width. When 'Splitstone' is specified, Hinuera Natural Stone recommend a minimum cover or overlap of 20mm to allow for undulation in the stone.

Refer to section 4.14 for detailed information about flashing requirements.

## 4.12 Sills

It is good trade practice and recommended that all window sills have an overhang of 30 – 50mm and a minimum slope of 15°. However, these parameters are not essential and the performance of the veneer will not necessarily be negatively impacted if these figures are not fully achieved. The primary requirement is to ensure that a drip edge is formed to minimise the amount of rain water run-off running down the veneer face, causing mineral stains.

Hinuera Natural Stone can be supplied in the shape of standard sill blocks, which should be installed in the usual manner. Specially designed sill blocks are also available on request.

Refer to figures 4, 5 and 12.

## 4.13 Supporting Hinuera Natural Stone over openings (lintels)

There are two methods of supporting Hinuera Natural Stone over openings:

- (a) Traditional fixing – lintel bar spans from one side of opening to the other without contact with timber frame.
  - The lintel bar should be kept 15 – 20mm back from the face of the Hinuera Natural Stone.
  - Where openings are less than 2000mm wide, the lintel bar is required to have a seating of 100mm each side.
  - If the opening exceeds 2000mm, the seating requirement is 200mm each side.
  - The lintel bar may be either rebated into the underside of the stone in order to reduce its visibility or alternatively, a suitable groove may be cut along the back of the stone to accommodate the angle.

The size of the galvanised steel lintel bars must conform to the requirements of NZS 3604 Table 4 as detailed below.

**Table 4: lintel bar sizes**

Max lintel span (mm)	Maximum height of veneers supported					
	70mm Hinuera Stone veneer			90mm Hinuera Stone veneer		
	350mm	700mm	>700mm	350mm	700mm	>700mm
800mm	60x10	60x10	60x10	80x10	80x10	80x10
2000mm	60x60x6	60x60x6	60x60x6	60x60x6	60x60x6	80x80x6
2500mm	60x60x6	80x80x6	80x80x6	60x60x6	80x80x6	80x80x8
3000mm	80x80x6	80x80x6	125x75x6	80x80x6	80x80x8	90x90x10
3500mm	80x80x6	80x80x6	125x75x6	80x80x8	90x90x10	125x75x10
4000mm	80x80x6	125x75x6	125x75x6	80x80x10	125x75x6	150x90x10
4500mm	125x75x6	125x75x6		125x75x6	125x75x10	
4800mm	125x75x6	125x75x10		125x75x6	125x75x10	

### Note:

1. This table has been engineered by BRANZ and used in NZS 3604
2. All steel is galvanised. 60x10 is flat bar, 60x60x6 is steel angle
3. All spans over 2.0m in length are to be propped for seven days
4. Sizes apply when lintel bars are used in the traditional manner

- (b) Fixing the galvanised steel angle to the timber lintel
  - The steel angle is coach screwed to the timber lintel at 450mm centres using 75x10g coach screws.
  - The horizontal leg of the steel angle must be sufficiently wide to support the veneer, which may overhang 20mm.
  - The steel angle must not be attached in anyway to the veneer and is required to be a minimum of 10mm short of the opening width to accommodate any minor movement.
  - Where opening width exceeds 2400mm, the size of the timber lintel must be subject to specific design by an engineer.
  - Steel lintel that are fixed to frames require specific engineering designs.

## 4.14 Flashings

Correctly designed and installed flashings are essential to directing moisture to the bottom of the cavity and out through the weep holes. Responsibility to ensure that all flashings are correctly designed, supplied and installed rests with the various parties involved as follows:



- **Designer:** full specification and documentation defining flashing types and all locations where they are required.
- **Builder:** supply and installation of all specified pre-installed flashings (ie. those not embedded in mortar)
- **Stone layer:** supply and installation of all specified flashings required to be embedded in mortar, and notification to the builder if normal pre-installed flashings appear to have been omitted or overlooked.

In general, flashings should be installed prior to commencement of laying the Hinuera Natural Stone. In some instances flashings may have to be embedded in the mortar at the time of laying.

Ensure that kick-out battens or 40mm clouts left proud, are installed to hold the flashing off the wrap 20mm.

Dissimilar metals may react with each other causing staining and corrosion. Aluminium is particularly vulnerable to attack when in contact with a dissimilar metal such as galvanised steel or Zinalume®.

The design and detailing of the structure should not cause water to drip on to the veneer for extended periods. This includes condensation drainage from air-conditioning units, as staining may occur.

#### 4.15 Window/door heads (refer to figure 6)

- Must be flashed using an aluminium head flashing powder coated to match the window joinery. The flashing must be nailed to the timber lintel, span the cavity and project over the edge of the window frame. The building wrap must not be cut to accommodate the rear upstand of the flashing. Rather, the flashing must be placed on the outside face of the wrap and over-flashed with an additional piece of wrap or tape.
- The length of the aluminium flashing must be the same as the window/door frame.
- When laying stone above this flashing, a clear minimum finished gap of 2mm, preferably 5 – 10mm, is required.
- The additional use of a flexible polythene flashing from the lintel bar to the framing, plus the inclusion of weep holes, is optional.

#### 4.16 Sill flashings

- Use 200mm wide flexible polyethylene flashings such as Supercourse 500.
- The flashing must extend a minimum of 150mm each side of the sill and lie under the jamb flashings.
- The flashing must be stapled to the sill trimmer and allowed to hang freely into the cavity.
- Tack a 20 x 20mm (or similar) kick-out batten to ensure the flashing hangs in the middle of the cavity.

#### 4.17 Jamb flashings (refer to figure 7)

- Use 200mm wide flexible polyethylene flashings such as Supercourse 500.
- Tack the flashing to the stud closest to the jamb liner and allow it to curl into the cavity. Do not fix it flat to the building wrap.
- Extend the flashing 150mm top and bottom above and below the window frame. At the sill area, the jamb flashing must lie over the sill flashing. At the head, the jamb flashing must lie under the optional polyethylene head flashing, if installed.

## 4.15 Penetrations

Pipes and other services may pass across the cavity and through the Hinuera Natural Stone veneer. They are not permitted to travel horizontally along the length of the cavity.

Where penetrations exit the stone veneer, a flexible sealant must be installed between the pipe and the stone (refer figure 8).

When power meter boxes are installed, they must be sealed around the face between the Hinuera Natural Stone and the meter box using a flexible sealant. In addition, a 200mm wide polyethylene flashing (eg. Supercourse 500) must be positioned across the top, attached to the framing and taped on to the meter box extending 150mm each side. The sides are to be treated in the same manner and extend 150mm below the underside of the meter box (refer figure 9).

## 4.16 Vermin proofing

Any gaps in the Hinuera Natural Stone veneer, that are greater than 13mm in width, must be vermin proofed. Ensure that all weep holes and vent holes are approx. 10mm in width to eliminate the need for vermin proofing.

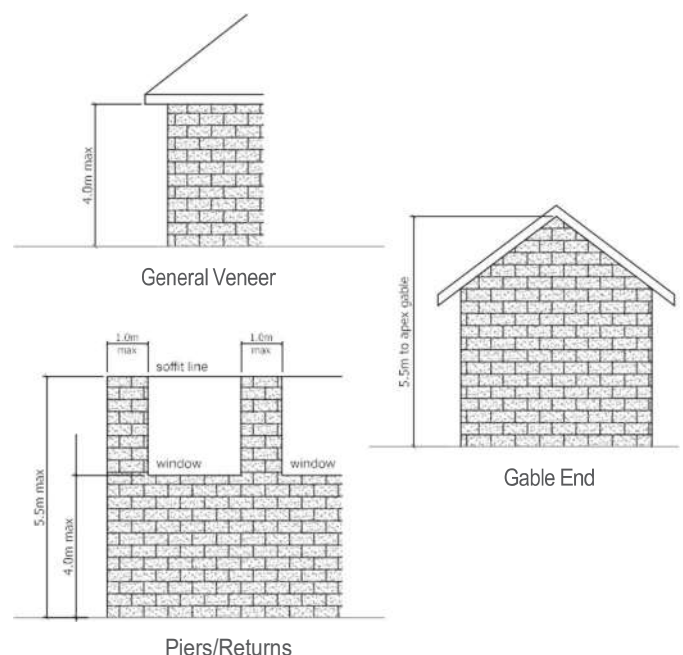
## 4.17 Height limitations for Hinuera Natural Stone veneers

A summary of these limitations are as follows:

- 7 metre maximum height above finished ground level
- 4 metre maximum height above a supporting foundation wall
- 5.5 metre maximum to the apex of a gable
- 5.5 metre maximum for a pier or return not exceeding 1.0m in width and not supporting a lintel bar

**Important:** if you wish to exceed the above stated height limitations, specific engineering design is required (refer to your design engineer).

### Maximum Heights - Hinuera Stone



## 4.18 Control joints

Where seismic control joints are positioned in any buildings, they must extend through the veneer. Hinuera Natural Stone does not require movement control joints under normal circumstances, however, on panels that are greater than 10 metres long without any openings, install 10mm joints at 5 to 6 metre intervals. Refer to NZS 4210 Section 2.10 for methods of controlling wall movements.

## 4.19 Sealing Hinuera Natural Stone veneer cladding

The sealing of Hinuera Natural Stone is not required to comply with the durability requirements specified within NZS 4210.

However application of a surface sealer will improve durability, and sealing is strongly recommended in geothermal areas, or in coastal areas where there is exposure to high salt levels in the atmosphere.

Sealing also provides aesthetic benefits. It makes cleaning easier, minimises mould and moss growth, and helps prevent possible stone discolouration such as mortar efflorescence.

There are many types of sealer coatings available. Some may alter the colour or appearance of Hinuera Natural Stone. Care is needed in the selection of an appropriate product and the sealer supplier(s) should be consulted before making a product choice. Refer to Appendix 1 for contact details of some organisations that have authorised listing of their names as independent providers of products and services which may be used in conjunction with Hinuera Natural Stone.

All sealer suppliers will be able to provide advice on surface preparation, application techniques, limitations, and precautions that are specific to their product(s). In some cases they may require their products to be applied by specialist contractors. Follow all suppliers' instructions.

**Important:** test the sealer on a small area first. If the result is not what was expected consult the sealant supplier(s) and/or Hinuera Natural Stone for instructions on how to proceed.

## 4.20 Maintenance of Hinuera Natural Stone veneer cladding

Designers should take care to ensure that rain water run-off is managed to prevent localised high flows (channelling) as this will cause mineral staining in the long term that is impossible to remove. The best solution is to provide drip edges where possible. Otherwise, it is essential that all efforts are employed to ensure that water running down the stone face is distributed over as wide a surface area as possible.

Hinuera Natural Stone can be subjected to numerous forms of staining during and after the construction process. As Hinuera Natural Stone is porous, and often has a rough surface or texture, it can be difficult to clean and remove the stain from the surface – therefore it is important to prevent it from happening.

When stains do occur, remove them as soon as possible. Most staining can be avoided simply by adopting good trade practices and protecting the stone from the activities of other adjacent trades.

Sealers must be re-applied when they become ineffective. Sealer durability will vary with product choice and environmental exposure conditions. Consult the sealer product supplier for recommended re-coat intervals.

Areas such as the South side of the house, or damp sections, may develop patches of green mossy growth indicating that the stone requires cleaning and re-sealing in that area.

Before using any cleaner, test its suitability on a small section to check its effect on the Stone's appearance. Hinuera Natural Stone must not be water blasted or scrubbed with a hard bristled brush as this can create pits and pores for the collection of moisture and dirt encouraging moss to grow.

Hinuera Natural Stone can be cleaned with most commercial cleaners specified as moss or mould cleaners.

Depending on the application, other cleaners may be required, eg. where grease or fats are an issue.

Some installers may provide a maintenance programme where required.

## 5.0

# Hinuera Natural Stone Slips



(Refer to figures 15 and 16)

## 5.1 General

Hinuera Natural Stone produces 'slips' for use as veneer facings in external and internal situations. The slips, are supplied in thicknesses up to 25mm in sawnstone and 40mm in Splitstone. They may be fixed by gluing with proprietary adhesive or mechanical fixings. Substrates may include masonry, concrete, or fibre cement board that has been approved by the manufacturer for this purpose. Hinuera Natural Stone slips **must not be glued** to plywood sheeting.

## 5.2 Weathertightness

Hinuera Natural Stone is a natural product and comparatively porous. Because of this it does not provide water-proofness, therefore the underlying substrate and structure must be suitably waterproofed and durable in its own right.

Substrate waterproofing must include both a suitable membrane along with appropriate detailing and flashing components. The ultimate test of adequacy of the waterproofing is that the building must be 100% functionally weathertight prior to the Hinuera Natural Stone slips being installed.

## 5.3 Substrate

Hinuera Natural Stone slips provide an excellent solution for many designs being considered. However, like any product, it must be used as part of a complete system – note that Hinuera Natural Stone supplies the slips only. Responsibility for the substrate rests with the substrate supplier.

It is very important when applying a stone slip system to ensure that all surfaces where adhesive is to be applied are free of dust, dirt, greasy deposits, loosely adhering surface coatings, releasing agents, or anything else that would limit the adhesive performance.

### 531 Over masonry or concrete (refer to figure 15)

In addition to the structural substrate, the system components are:

- Waterproofing membrane
- Adhesive
- Mortar
- Hinuera Natural Stone slips
- Sealer

The adhesive and mortar components interact significantly and so must be sourced from one supplier. It is likely that the waterproofing membrane will also be available from the adhesive supplier. If not, the adhesive and waterproofing membrane suppliers must confirm mutual compatibility of their products.

Refer to Appendix 1 for contact details of some organisations that have authorised listing of their names as independent providers of products and services which may be used in conjunction with Hinuera Natural Stone.

All adhesive, mortar and waterproofing membrane suppliers will be able to provide advice on surface preparation, application techniques, limitations, and precautions that are specific to their product(s). In some cases they may require their products to be applied by specialist contractors. Follow all suppliers' instructions.

Refer to section 4.19 of this manual for advice on sealers.

### 532 Over fibre cement sheets

Hinuera Natural Stone Slips have been successfully applied over fibre cement sheets.

The success of such an application is dependant on a complete specification and installation process and will include similar components as stated previously under the masonry and concrete section.

The proprietary fibre cement cladding system will incorporate a fully ventilated and drained cavity system, flashed and sealed, such as the PBS Ventclad system. The Hinuera Natural Stone slips are then applied as a separate specification and process.

It is the responsibility of the specifier to provide a complete system specification from a suitable substrate or cladding supplier. The thickness of fibre cement sheets and the installation of control joints are both critical considerations.

### 533 Mechanical fixing of Hinuera Natural Stone slips (refer to figure 16)

In commercial applications support can be provided for Hinuera Natural Stone slabs by using stainless steel shelf angles and stainless steel pins. Mechanical fixing is generally used with concrete or masonry substrates, not thin sheet substrates such as fibre cement.



Hinuera Natural Stone recommend that all mechanical fixing options be investigated at the design stage in conjunction with a structural engineer.

## 5.4 Similarity to veneer claddings

Much of the information provided in this publication for veneer cladding also applies to slips. Readers are referred to section 4 for additional important guidance. In particular, the sections listed below should be reviewed. Not all of the information in these sections is relevant to slips. If any doubt exists regarding the relevance of any particular comment to the project in hand, the reader should consult Hinuera Natural Stone.

4.1	Related documents
4.2	Foundations
4.3	Timber framing
4.6	Stone installer
4.7	General laying specification
4.11	Window and door openings
4.12	Sills
4.18	Construction joints
4.19	Sealing Hinuera Natural Stone veneer claddings
4.20	Maintenance of Hinuera Natural Stone veneer claddings

## 5.5 Important notice

### Important information when adhering Hinuera Natural Stone to membranes on exterior walls.

When adhering Hinuera Natural Stone to walls over waterproofing membranes, it all comes down to the cohesive capability of the membrane to carry the weight of Hinuera Natural Stone unsupported. Cohesive failure is brought about by various forces acting upon the Hinuera Natural Stone such as wind, sun, rain plus freeze thaw.

Thinner Hinuera Natural Stone naturally perform better because their centre of gravity is closer to the wall eg. 25mm Hinuera Natural Stone Sawn compared to 40mm Hinuera Natural Stone Splitstone. This reduces the fulcrum effect.

Another factor is gaps behind the Hinuera Natural Stone, which entrap any ingressing water or condensation. This sits on the surface of the membrane and can have a softening effect, especially with the introduction of heat from the sun which can create a pressure cooker scenario.

This can somewhat be avoided by notch trowelling the wall first, and then the back of the Hinuera Natural Stone. When the Hinuera Natural Stone is placed on the wall, a crosshatch of the adhesive is achieved, which in turn greatly reduces notch trowel voids.

Certain adhesives in their own right when adhering directly to a masonry wall can carry up to 70kg of Hinuera Natural Stone per square metre. They are cohesively very strong when cured. This is based on 100% surface adhesion. Different adhesives would have different weight capabilities.

However this is severely reduced when a membrane is introduced. Various substrates with membranes applied, such as, fibre cement and concrete, indicate weight per square metre capabilities averaging between 25kg and 32kg per square metre. This gives an indication of the severe reduction factor. Although these figures are within the realms of expectation, Hinuera Natural Stone recommends a weight no greater than 25kg per square metre be applied to a membrane without support.

Don't forget the wet state of Hinuera Natural Stone is greater than the dry weight.

It is recommended that when Hinuera Natural Stone is adhered onto a membrane that stainless (near the sea) or aluminium angles, clips or pins be used within the grout lines to support the shear weight of Hinuera Natural Stone. The bottom row if unsupported by a footing should always be laid onto a fixed angle.

It also should be noted that some masons, stone layers and bricklayers still practice the spot method of adhesion. This results in point pressure on the substrate and in effect offers sometimes less than 50% adhesion. Should the weight of Hinuera Natural Stone be 25kg per square metre and the spot method of adhesion be used, the transfer of weight hypothetically is doubled if only 50% surface adhesion is achieved. Spot adhesion is unacceptable.

In conclusion, when adhering Hinuera Natural Stone to walls which have a membrane, reduce the shear weight by using stainless (near the sea) or aluminium angles, clips or pins within the grout lines.

Other factors also need to be added:

- No spot adhesion
- No evidence of notch trowel lines which can hold water
- 100% surface adhesion
- Use angles, clips or pins to reduce the shear weight.

## 6.0

# Hinuera Natural Stone Paving



Hinuera Natural paving has excellent slip resistance qualities for total non-slip areas and rates highly under the slip resistance code. This makes it an excellent choice for areas such as terraces, patios and pool areas. Hinuera Natural Stone paving does not heat up under the sun like other paving.

Hinuera Natural Stone must always be placed on a solid concrete slab. It is not acceptable to lay Hinuera Stone directly onto an unbound granular base, no matter how well it is compacted or prepared.

Hinuera Natural Stone can be fixed in place with either a mortar mix or by standard tiling practices. Keep the paving as clean as possible during laying. Ensure any marks or stains incurred during installation are removed as soon as practicable.

**Important note:** Hinuera Natural Stone Awa Select Grade is not recommended for use around salt water pools. Hinuera Natural Stone is not recommended for use in high traffic or commercial paving applications.

### 6.1 Moisture barrier

A moisture barrier must be provided between the ground and the paving by placing a DPM (polythene) or by sealing the concrete with a waterproof sealer. Refer to figure 17.

Refer to Appendix 1 for contact details of some organisations that have authorised the listing of their names as independent providers of products and services which may be used in conjunction with Hinuera Natural Stone.

**Important note:** should the concrete not be waterproofed, leaching of salt from either ground contact or concrete could cause salt depositions beneath the stone surface (as a result of water evaporation), which may lead to the exterior stone surface blistering and delaminating.

### 6.2 Mortar fixing

Hinuera Natural Stone recommend the use of bagged trade mortar for this application such as Dricon Cemix or other commercially produced mortars.

When using site-mixed mortar, ensure that only river washed sand is used, as beach sands may cause continual leaching of salts, which appear as a white powder on the surface of the stone ('efflorescence')

lowering its aesthetic appeal and may lead to delamination of the stone surface. For this reason, factory blended quality controlled products such as bagged trade mortar are preferred.

### 6.3 Tile cement adhesive

It is important that the backs of the paving slabs are buttered with the tile cement adhesive to ensure a good bond when laid. The adhesive bed thickness should not be less than 5mm.

Other tile adhesives can be used. Refer to Appendix 1 for contact details of some organisations that have authorised listing of their names as independent providers of products and services which may be used in conjunction with Hinuera Natural Stone.

### 6.4 Joints

The recommended procedure for filling the joints between the paving is to use a dry mix of silica sand and cement at a 3:1 sand to cement ratio.

Tool this mix into the joints to ensure that it provides a good bond and seal. Tooling is best carried out the day after the paving is laid. It is recommended to tool dry as this makes it easier to clean and minimises residue.

Mortar joints should be wide enough to ensure that good bonding and sealing is achieved, without this bond water could move through the joints and get under the paving.

After laying is finished and the joints have been filled and tooled, the Hinuera Natural Stone paving area can be washed thoroughly with hot water to remove any marks or stains incurred during installation, then allowed to dry before sealing.

### 6.5 Maintenance of Hinuera Natural Stone paving

A surface sealer for Hinuera Natural Stone paving is required after installation for protection, durability and ease of cleaning.

Once sealed, you may find some areas do not require frequent repeat treatment. These are normally areas that are protected from continuous excessive rain. In other areas like the south side of the house, shaded areas or damp sections it is common for patches of green mossy growth to develop indicating that the stone requires a clean and resealing in that area.

Before using any cleaner, test the suitability in a small section to check its effect on the Stone's appearance. Hinuera Natural Stone can be cleaned with most commercial cleaners.

Depending on the application, other cleaners may be required eg. where grease or fats are an issue.

Internal paving requires a barrier sealer to provide a surface that is more stain resistant and easier to clean. Refer to Appendix 1 for contact details of some organisations that have authorised the listing of their names as independent providers of products and services which may be used in conjunction with Hinuera Natural Stone.

Hinuera Natural Stone should not be waterblasted or scrubbed with a hard bristled brush as this can create pits and pores in the stone which will allow for the collection of moisture and dirt, encouraging moss to grow.

Some installer companies will provide a maintenance programme where required.

## Important Notice

This manual has been prepared by Hinuera Natural Stone.

The purpose of this Manual is to provide a 'Specific Design' on how Hinuera Natural Stone is to be installed as a masonry veneer. In addition, to provide some guidance on the use of Hinuera Natural Stone in a 'stone slip' situation and when used as pavers. Any person contemplating using Hinuera Natural Stone should determine the appropriateness and suitability of the information contained in this document for their specific and current requirements.

Notwithstanding the contents of this manual, construction with Hinuera Natural Stone should be undertaken in accordance with the New Zealand Building Code, all relevant statutory and regulatory requirements and all relevant New Zealand standards.

Further, the successful construction with Hinuera Natural Stone is dependent on numerous factors outside Hinuera Natural Stone's control – for example, quality of workmanship, particular design requirements and non-Hinuera Natural Stone products etc. Hinuera Natural Stone will not be liable in relation to any of these factors.

The information contained in the manual is believed to be correct at the time it was prepared but no representation or warranty, express or implied (other than as may be implied by law) is made by Hinuera Natural Stone, its officers, employees or agents as to its accuracy, reliability or completeness.

Hinuera Natural Stone is not under obligation to update any information and/or recommendations contained in this manual or to notify any person should any such information and/or recommendations cease to be correct after the date of this manual is published.

To the fullest extent permitted by law, Hinuera Natural Stone excludes all liability for:

- Any misstatement, error or omission in relation to the information and/or recommendations contained in this manual; and
- Any damages, losses, costs or expenses including, without limitation, direct, special or consequential damages (including but not limited to damages arising from negligence) arising from or in connection with any access to, use of or reliance on the contents of this manual.

If you are using this manual for business purposes, you agree that the provisions of the Consumers Guarantees Act 1993 will not apply, to the extent that contracting out is permitted by that Act.



## Appendix 1: Associated products and services listing

Item or service	Function	Product name	Supplier	Contact numbers
Waterproofing sealer	Coating foundation Recesses Paving Moisture barrier	Mulseal	Sika (NZ) Ltd	09 820 2900 04 568 7965 03 366 8914 0800 745 269
Mortar	Laying stone as veneer cladding or paving	Dricon Trade Mortar	Dricon PO Box 132 Tuakau Auckland	0800 374 266
		Ezy Mix		07 888 4328 www.ezymix.co.nz
Sealants (joints)	Sealing control joints and around penetrations	Silaflex MS	Sika (NZ) Ltd	09 820 2900 04 568 7965 03 366 8914 0800 745 269
Sealers (coatings) and barrier sealers	Sealing Hinuera Natural Stone	Aquamix	Global Tiles 81 May Road Onehunga Auckland	09 634 0712 www.aquamix.co.nz
		Aqua Stop SI-10 silicone sealant	Flexco (NZ) Ltd 67 Dalgety Drive Manukau City Auckland	09 268 6970 0800 426 844 www.flexco-nz.co.nz
		Hinuera Natural Stone Sealer	Hinuera Natural Stone PO Box 89 Matamata	0800 HINUERA www.hinuera.co.nz
		Latasil tile and Stone sealant	Laticrete Systems Mobile Ceramics PO Box 38 435 Howick, Auckland	09 535 1672 0800 480 018 www.laticrete.com.au
Algae and moss remover	Cleaning Hinuera Natural Stone	Orgo Clean	Flexco (NZ) Ltd 67 Dalgety Drive Manukau City Auckland	09 268 6970 0800 426 844 www.flexco-nz.co.nz
		Chem Wash 30 Seconds	www.chemwash.co.nz www.30seconds.co.nz	0800 CHEMWASH available at hardware stores throughout NZ
Maintenance	Cleaning/Sealing		Slique PO Box 147 383 Ponsonby Auckland	0800 754 783 www.slique.co.nz
Substrate for slips	Substrate for slips	Eterpan VentClad System	Island Stone NZ LTD 6 Erica Street Tauranga	07 574 1289 sales@islandstone.co.nz
Slip fixing – mechanical	Mechanical support for Hinuera Natural Stone slips	Unistrut	Unistrut NZ Ltd PO Box 13 240 Onehunga Auckland	09 634 0530
Slip fixing – adhesive	Gluing Hinuera Natural Stone slips	Mapei NZ Ltd	Mapei NZ Ltd 39 Fisher Cres, Mt Wellington	09 921 1994 enquiries@mapei.co.nz www.mapei.co.nz
		Megamotar Stone and Schist Flexi Wall'n Floor 2 Part	Flexco (NZ) Ltd 67 Dalgety Drive Manukau City Auckland	09 268 6970 0800 426 844 www.flexco-nz.co.nz

**Please note:** Hinuera Natural Stone is a supplier of natural stone building materials to the market. Hinuera Natural Stone takes no responsibility for the fitness for purpose or quality of all or any other products used. You are strongly recommended to seek references and performance commitments from the product supplier(s) and are required to take all necessary steps to make your own informed choice.

## Appendix 2: Designer's checklist

### Sketch Plans - Working Drawings - Building Consent

Job No. \_\_\_\_\_ Date \_\_\_\_\_ Designer \_\_\_\_\_

Site address \_\_\_\_\_

Lot \_\_\_\_\_ DP \_\_\_\_\_ Owner \_\_\_\_\_

#### Selected Hinuera Natural Stone

##### Thickness

20mm	25mm	40mm	60mm	70mm	90mm	Other:

##### Required Face

Sawn
  Split

##### Use(s)

Veneer cladding	Slips	Sills	Paving	Stair treads	Other:

Size(s) Specified \_\_\_\_\_

##### Grade(s) Specified

Ahi	Awa	Awa Select	Kaha	Kaha Select

##### Product

Natural
  Golden Haze

##### Other

##### Sketch

- |   |   |
|---|---|
| <input type="checkbox"/> Site coverage                  | <input type="checkbox"/> Difficult windows addressed  |
| <input type="checkbox"/> Site access                    | <input type="checkbox"/> Window and door locations – adequate wall length available for bracing |
| <input type="checkbox"/> Piers and returns – min. 230mm | <input type="checkbox"/> Has the Hinuera Natural Stone grade, size etc been selected?           |

##### Working

- |   |   |
|---|---|
| <input type="checkbox"/> Have the design team read the Hinuera Natural Stone guide? | <input type="checkbox"/> Checked maximum heights of veneer                                      |
| <input type="checkbox"/> Foundation/Slab edge detailing addressed                   | <input type="checkbox"/> Columns – have they been constructed as veneers?                       |
| <input type="checkbox"/> Control joints – are they required?                        | <input type="checkbox"/> Check cavity width: 40-75mm, rec 50mm                                  |
| <input type="checkbox"/> – if so have they been documented?                         | <input type="checkbox"/> Considered Hinuera Natural Stone above opening heads                   |
| <input type="checkbox"/> Checked required timber treatments                         | <input type="checkbox"/> Has the method of support above openings been decided?                 |
| <input type="checkbox"/> Structural beams – engineered, steel etc.                  | <input type="checkbox"/> Has penetration detailing been specified?                              |
| <input type="checkbox"/> Gable ends – heights and sheathing requirement (E2/AS1)    | <input type="checkbox"/> Vermin proofing required/provided                                      |
| <input type="checkbox"/> Cladding tight areas – fixing available for veneer ties    | <input type="checkbox"/> Have the lintel bar sizes been stated on the plans?                    |
| <input type="checkbox"/> Decks and pergolas – construction method selected          | <input type="checkbox"/> Is Hinuera Natural Stone specified correctly?                          |
| <input type="checkbox"/> – fixing type and size designed                            | <input type="checkbox"/> Mortar colour specified  |
| <input type="checkbox"/> Flashings required – are they detailed on the plans        | <input type="checkbox"/> Hinuera Natural Stone contacted to discuss special sizes and/or shapes |
| <input type="checkbox"/> Weep holes type and layout specified                       | <input type="checkbox"/> A suitable sealer is selected and specified                            |
| <input type="checkbox"/> Ventilation method specified                               |   |

##### Consent

Has all relevant information been submitted?

Have the required inspections been stipulated?



## Appendix 3: Builder's/Supervisor's checklist

Job No. \_\_\_\_\_ Date \_\_\_\_\_ Supervisor \_\_\_\_\_

Address \_\_\_\_\_ Builder \_\_\_\_\_

Lot \_\_\_\_\_ DP \_\_\_\_\_ Owner \_\_\_\_\_

### Slab

- Have all parties read and understood the Hinuera Natural Stone guide?
- Slab recess depth correct – 100mm recommended
- Is the slab straight?
- Two coats of bitumen emulsion applied to recess
- Can a 50mm cavity be achieved?
- Checked ground clearance
- 
- Slab recess width correct – 130mm recommended
- 
- 150mm for split stone

### Timber/Structure

- Checked required timber treatments
- Discussed any issues that affect the roofer
- Checked required stud spacings
- Installed flashing 'stop-ends' where required
- Correct building wrap used
- Checked the installation of the shelf angles
- Correct flashings ordered and installed
- Organised joinery site measure and installation
- Framing for control joints installed
- Organised and installed aluminium head flashings
- Organised scaffolding (if required)
- Check window and door flashings plus air seals (E2/AS1)
- Discussed stone work with the stone mason
- Are downpipes diverted?

### Laying

- Checked Hinuera Natural Stone product received is correct
- Record cement/sand/water/additive quantities
- Are the stone quantities correct including specials?
- Is the veneer being cleaned as job progresses?
- Is the stone being protected from the elements?
- Is the Hinuera Natural Stone being tied to the spec?
- Is stone being blended from three pallets?
- 'Shelf angle' inspections booked if required
- Are mortar components being measured accurately?
- Has the sealer been applied?
- What mix formula is being used?

## Appendix 4: Stone Mason's checklist

Job No. \_\_\_\_\_ Date \_\_\_\_\_ Layer \_\_\_\_\_

Address \_\_\_\_\_

Lot \_\_\_\_\_ DP \_\_\_\_\_ Owner \_\_\_\_\_

- Have staff read and understand Hinuera Natural Stone guide?
- Has Hinuera Natural Stone been ordered?
- Are stone quantities correct?
- Checked positioning of stone on site
- Checked correct product has been delivered
- Checked if stainless steel ties required
- Site safety – falling bricks – checked
- Stone and stone work is protected
- Diamond saw location – okay
- Veneer around hose taps protected
- Control joints – where required
- Inspections for 'shelf angles' required/booked
- Mortar components measured accurately
- Mortar mixed adequately
- Provided mortar formula to supervisor
- Veneer is being cleaned as job progresses
- Mortar joints are consistent thickness
- Mortar joints have been tooled
- Windows/doors correctly flashed
- Have weep holes been installed correctly?
- Correct size lintels used
- Has the sealer been applied?

## Appendix 5: Drawings

Note: these details are drawn showing Splitstone. All details are identical for Sawnstone except where noted.

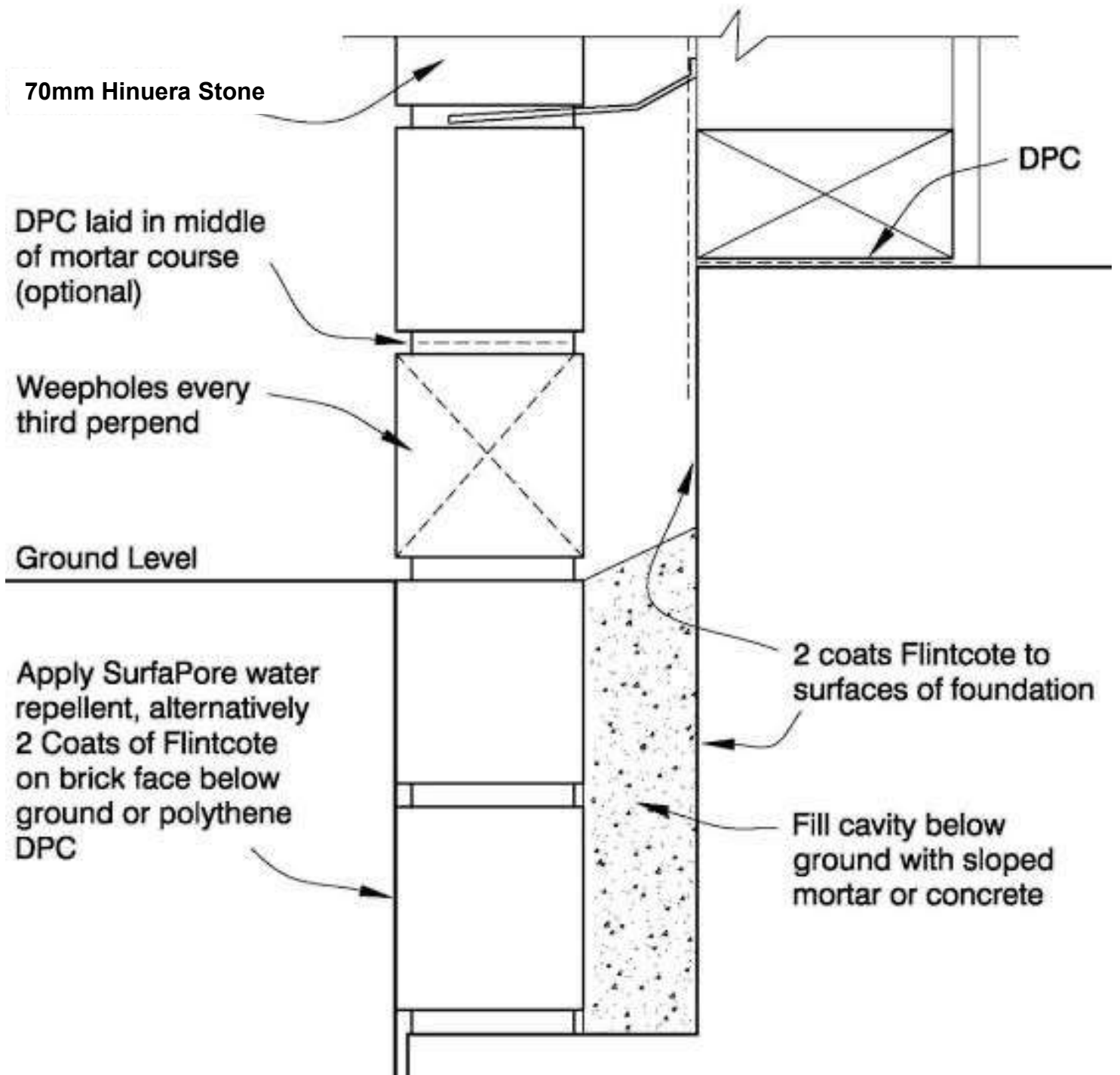


Figure 1: Hinuera Natural Stone Ground Floor

## Appendix 5: Drawings

Brick ties at 600mm crs horizontally and 400mm crs vertically, (approx 5/sqm). Consecutive rows of ties in the bottom two mortar courses when an impervious membrane has been used to water-proof the foundation recess.

Building paper

Cavity 40-75mm  
50mm recommended

Hinuera Natural Splitstone

Seal recess area using two coats of bitumen emulsion or an impervious membrane

80 x 10mm weep holes at 800crs or 1000sqmm per lin. metre

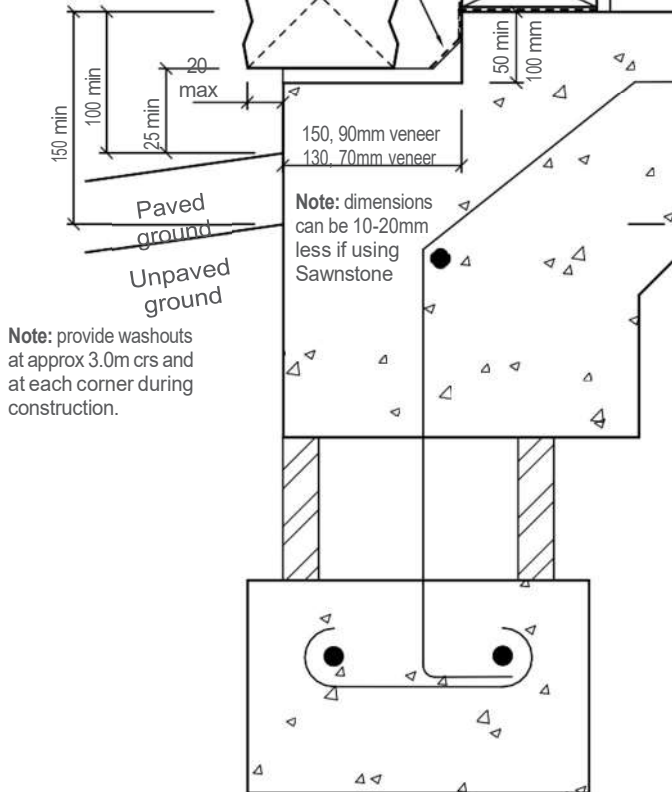


Figure 2: Hinuera Natural Stone Foundation Base Detail

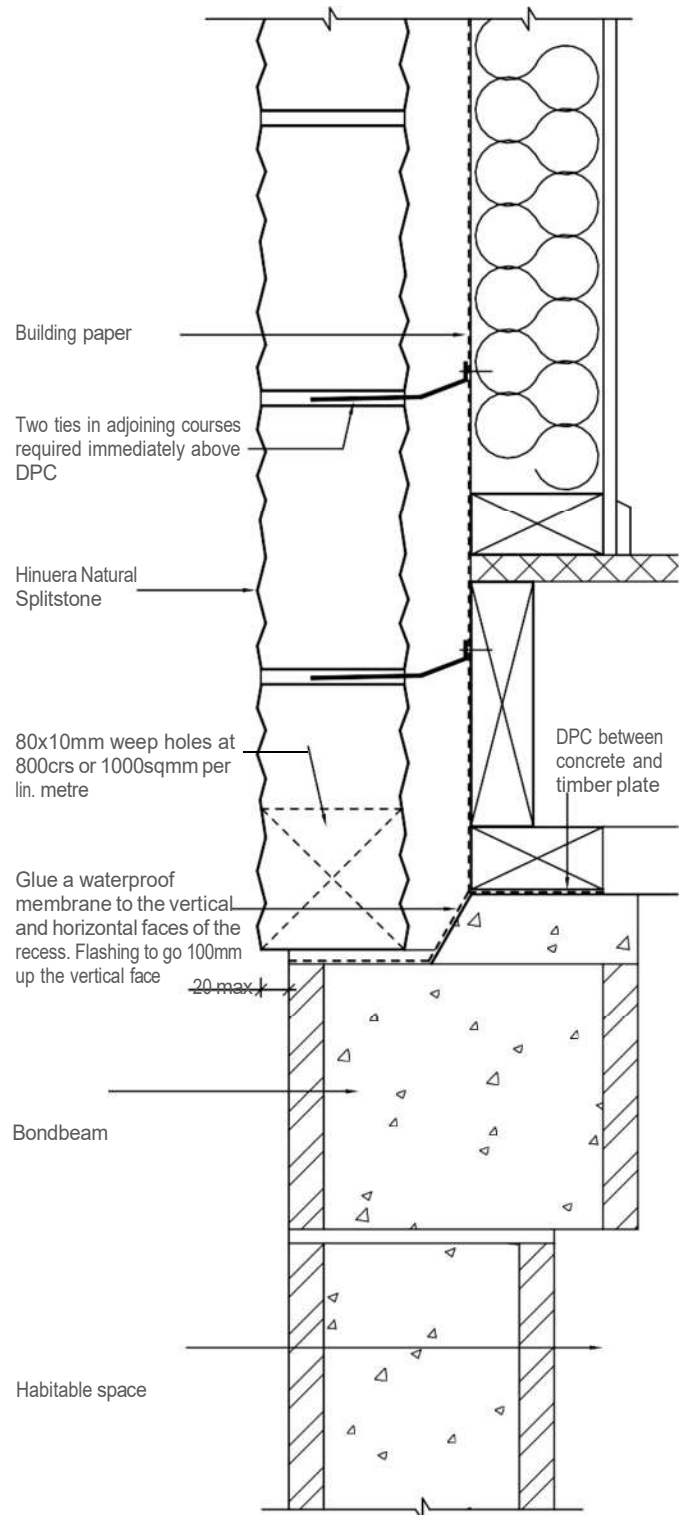
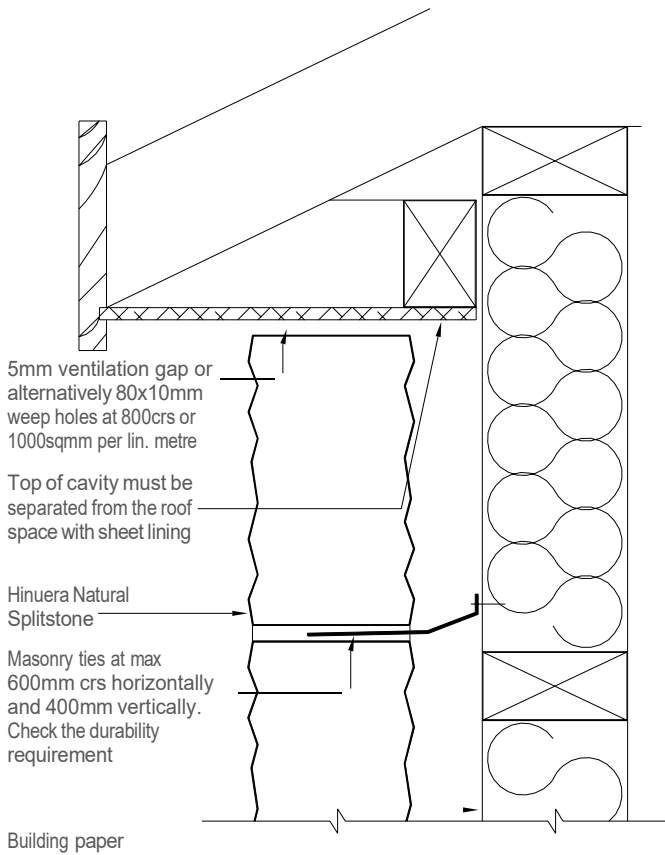


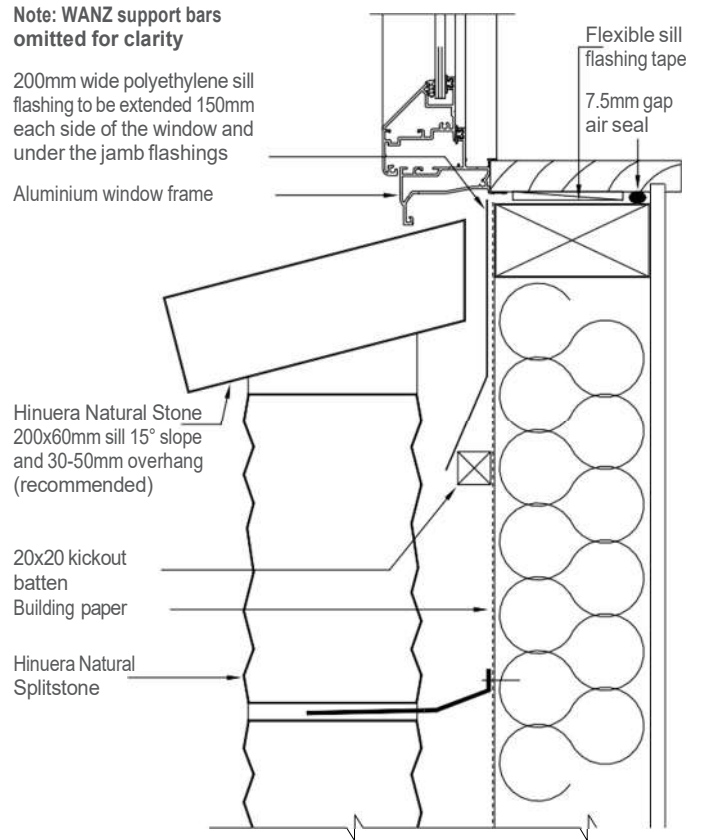
Figure 3: Hinuera Natural Stone Block Base Detail



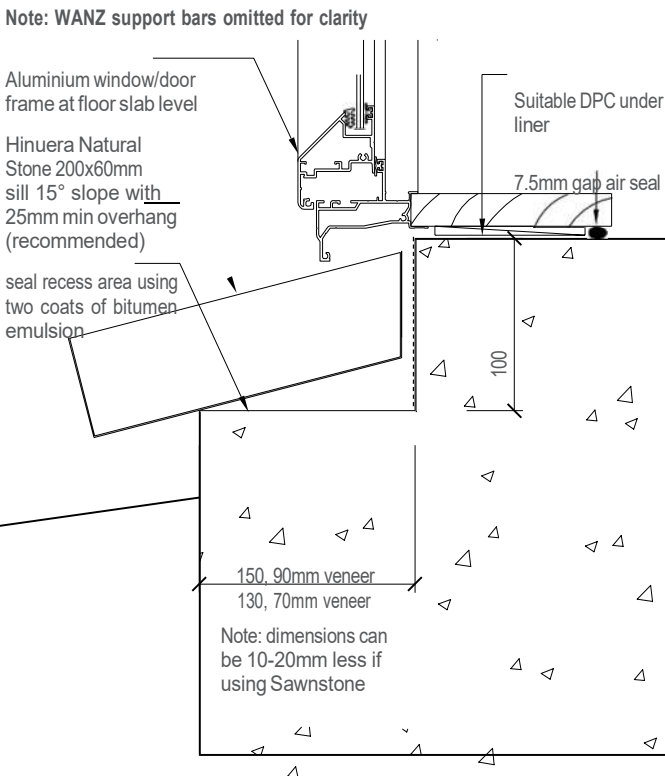
## Appendix 5: Drawings



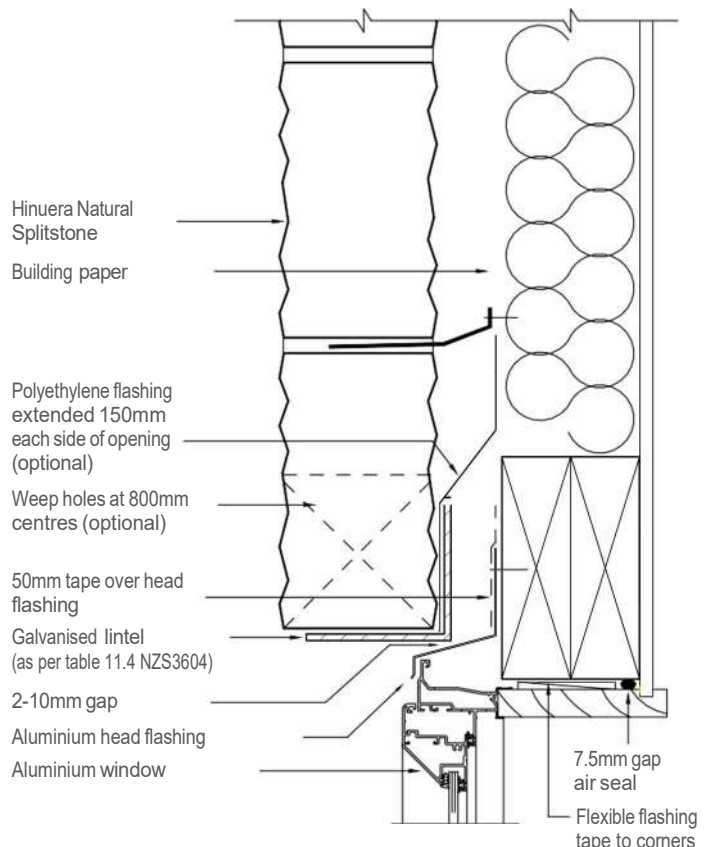
**Figure 4: Hinuera Natural Stone Soffit Detail**



**Figure 5: Hinuera Natural Stone Window Sill Detail**

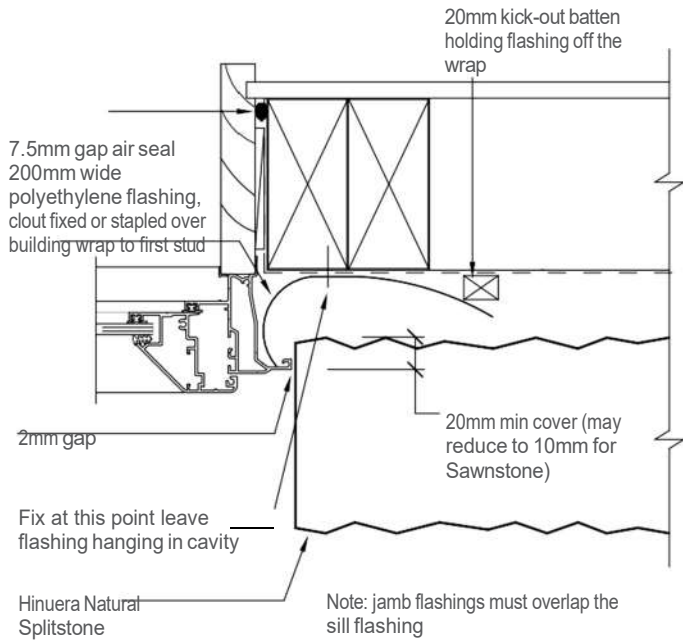


**Figure 6: Hinuera Natural Stone Window/Door Sill Detail**

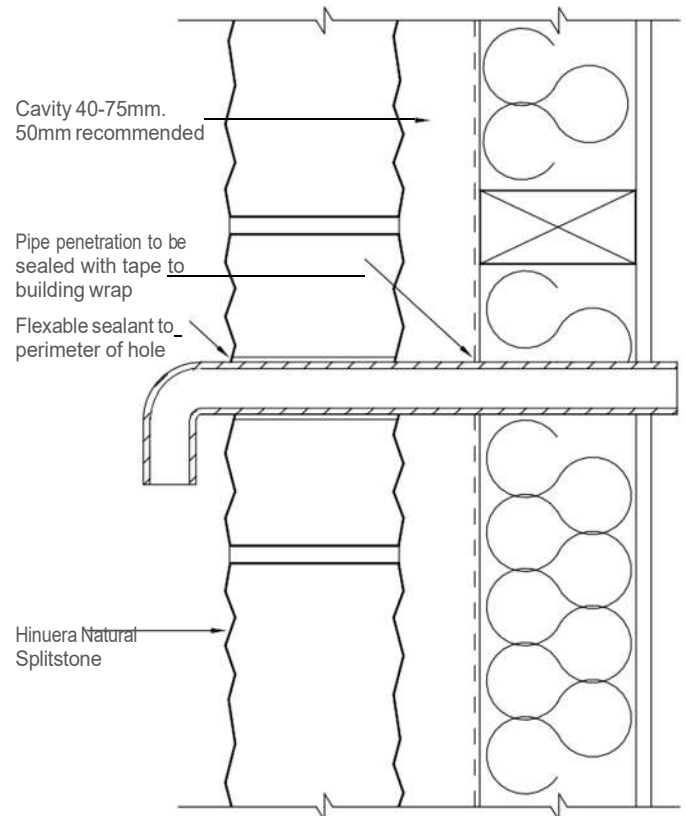


**Figure 7: Hinuera Natural Stone Window Head Detail**

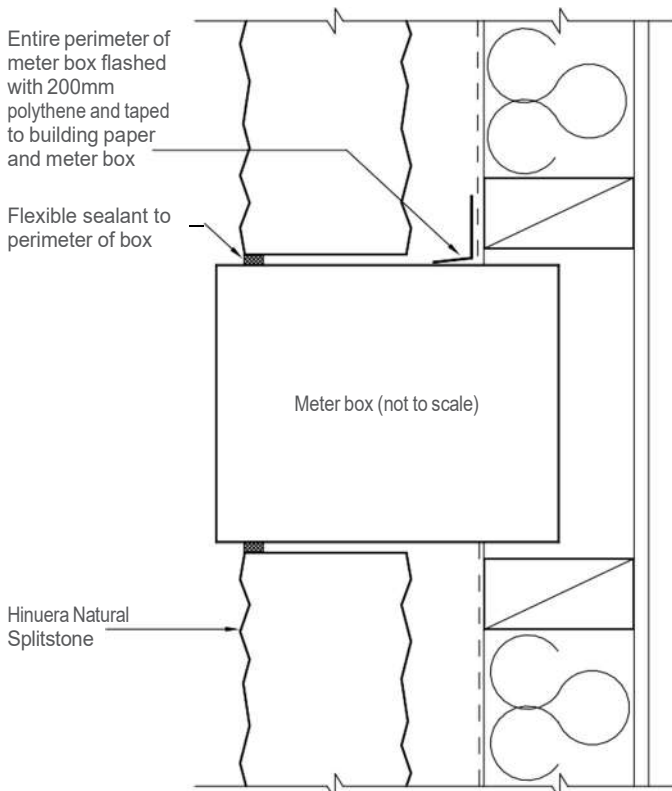
## Appendix 5: Drawings



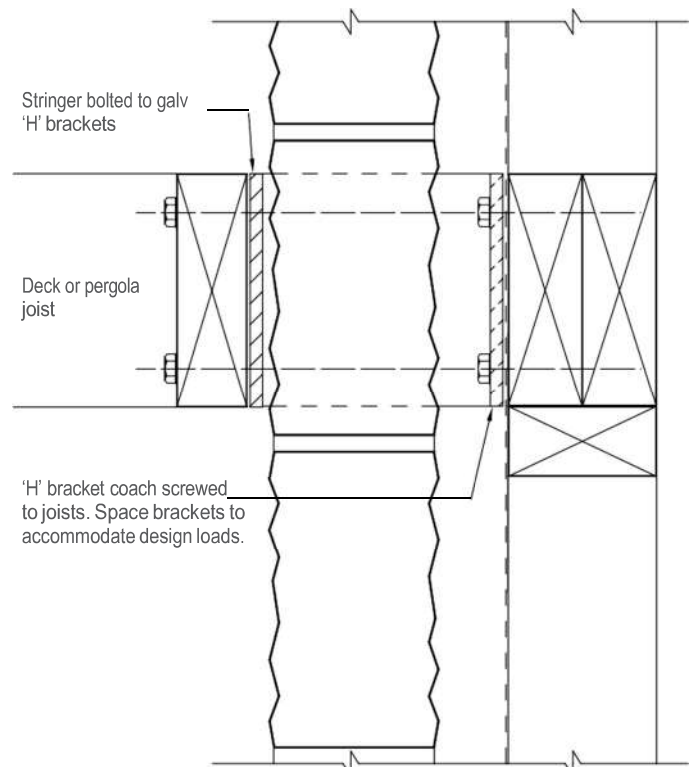
**Figure 8: Hinuera Natural Stone Window Jamb Detail**



**Figure 9: Hinuera Natural Stone Pipe Penetration**

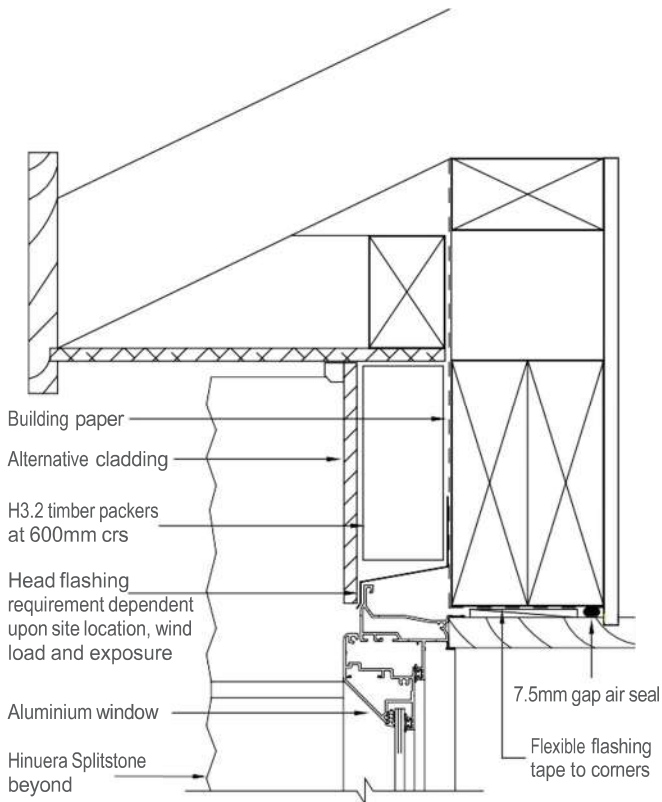


**Figure 10: Hinuera Natural Stone Meter Box**

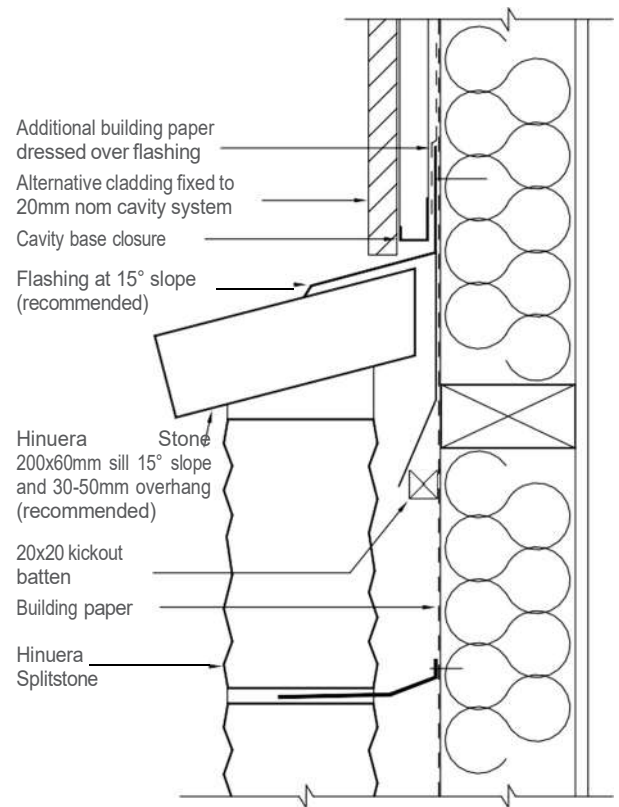


**Figure 11: Hinuera Natural Stone Attachment of Pergolas and Decks**

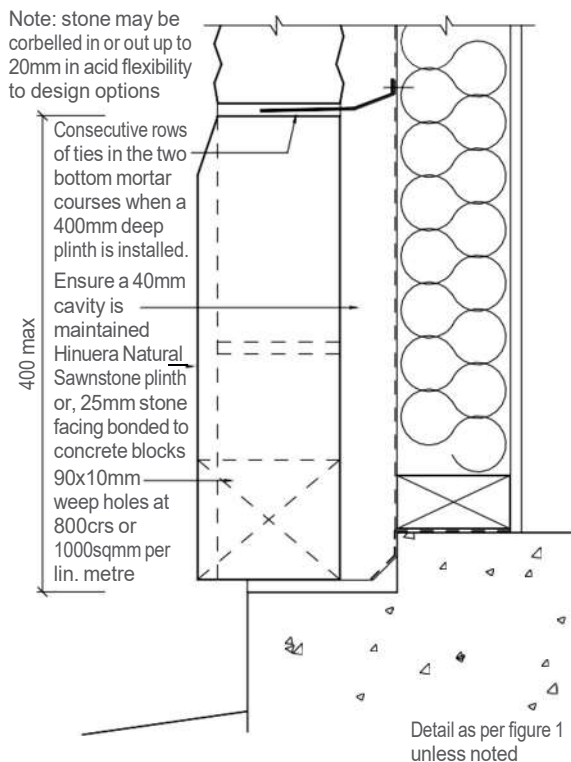
## Appendix 5: Drawings



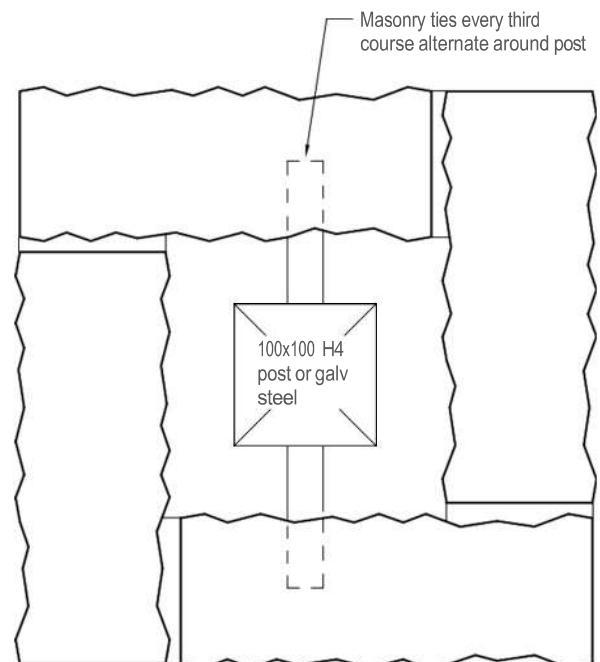
**Figure 12: Hinuera Natural Stone Window Head Detail (alternative head cladding)**



**Figure 13: Hinuera Natural Stone with Alternative Cladding**



**Figure 14: Hinuera Natural Stone Plinth Detail**



Notes: provide weep holes at the base.  
Provide waterproof capping to the top of the column.  
Embedded posts 1/3 into the ground or to specific engineering design.

**Figure 15: Hinuera Natural Stone Typical Column Detail**

## Appendix 5: Drawings

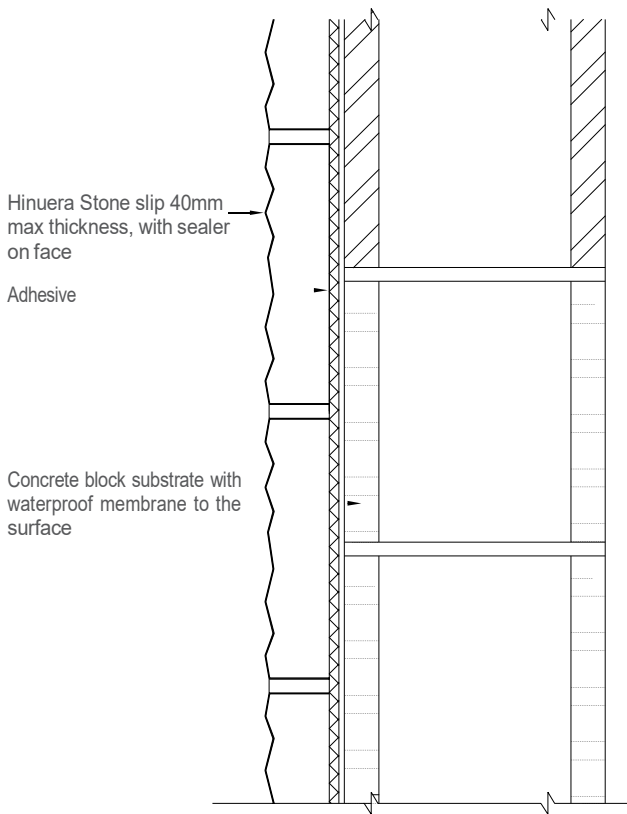


Figure 16: Hinuera Natural Stone Assembly onto Blockwork

Note: this application requires specific design and installation input from the manufacturers of the fixing system.

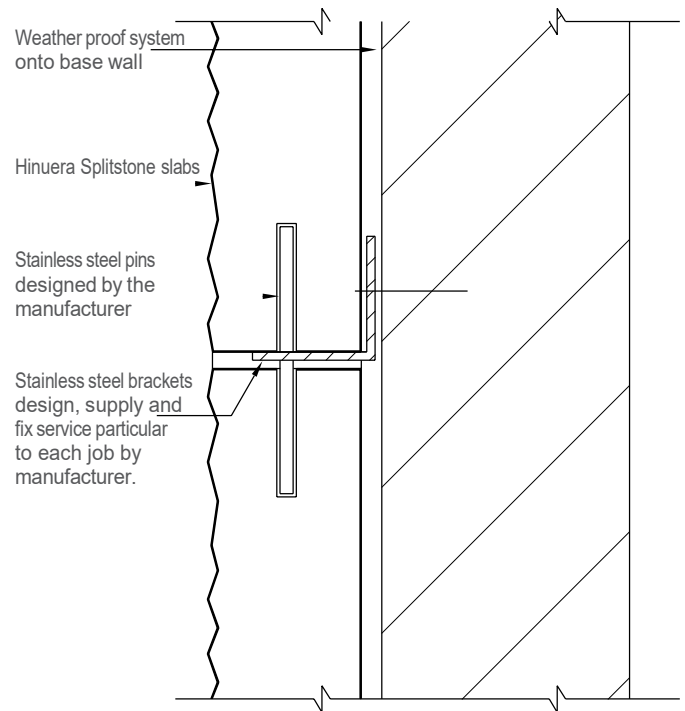


Figure 17: Hinuera Natural Stone with Mechanical Fixing

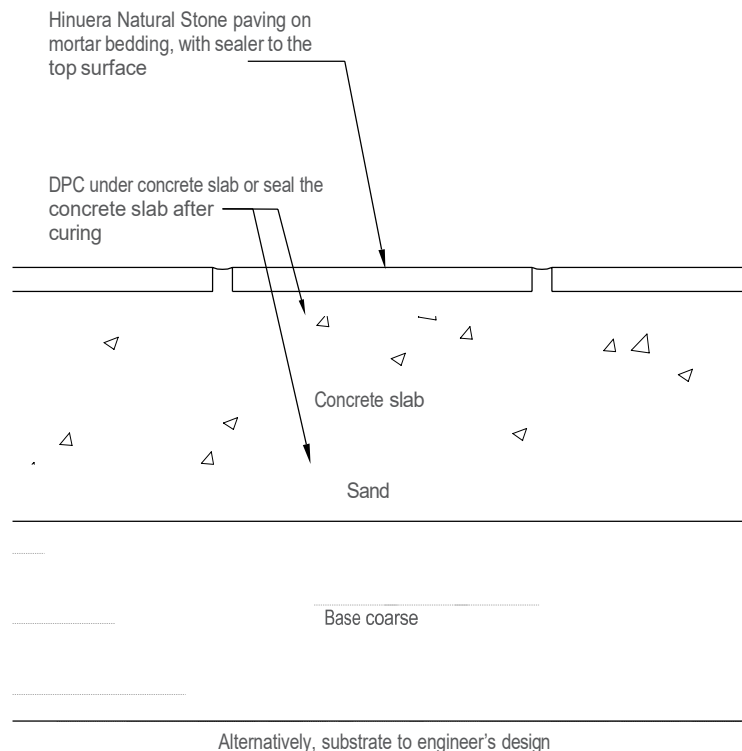


Figure 18: Hinuera Natural Stone Paving Detail



## Appendix 5: Drawings

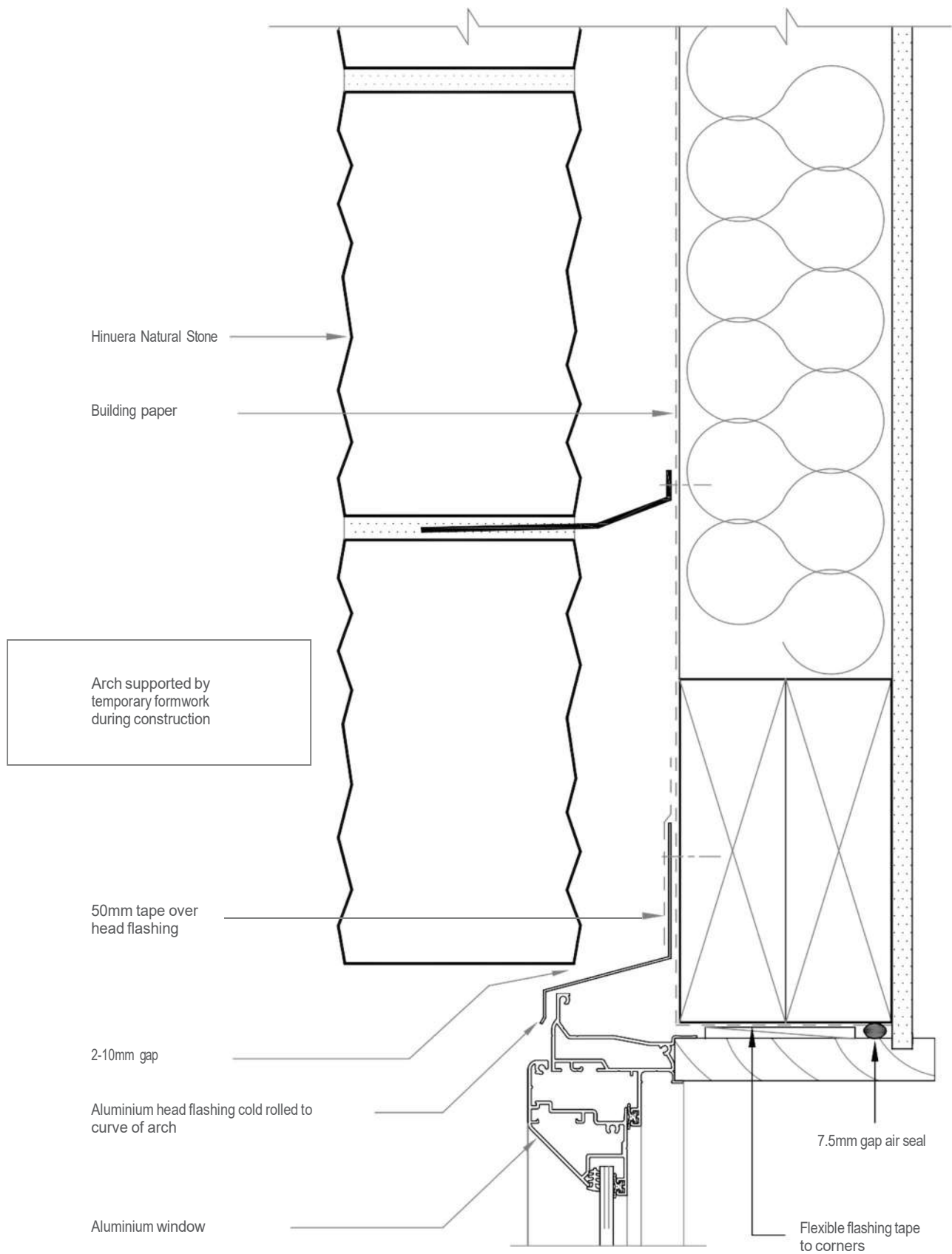
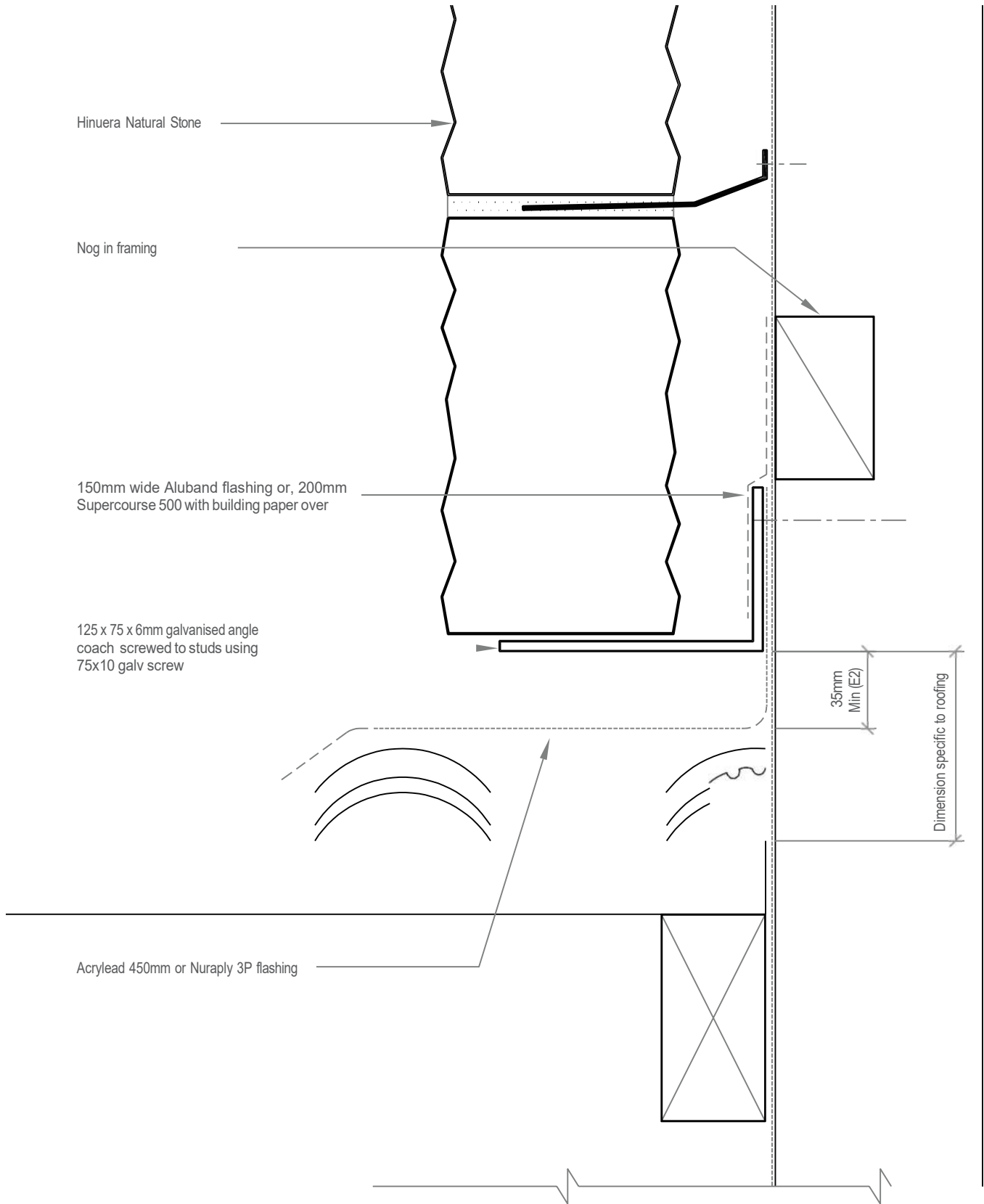


Figure 19: Hinuera Natural Stone Arch Window Head

# Appendix 5: Drawings



**Figure 20: Hinuera Natural Stone Sloping Shelf Angle Gutter/Wall Junction**

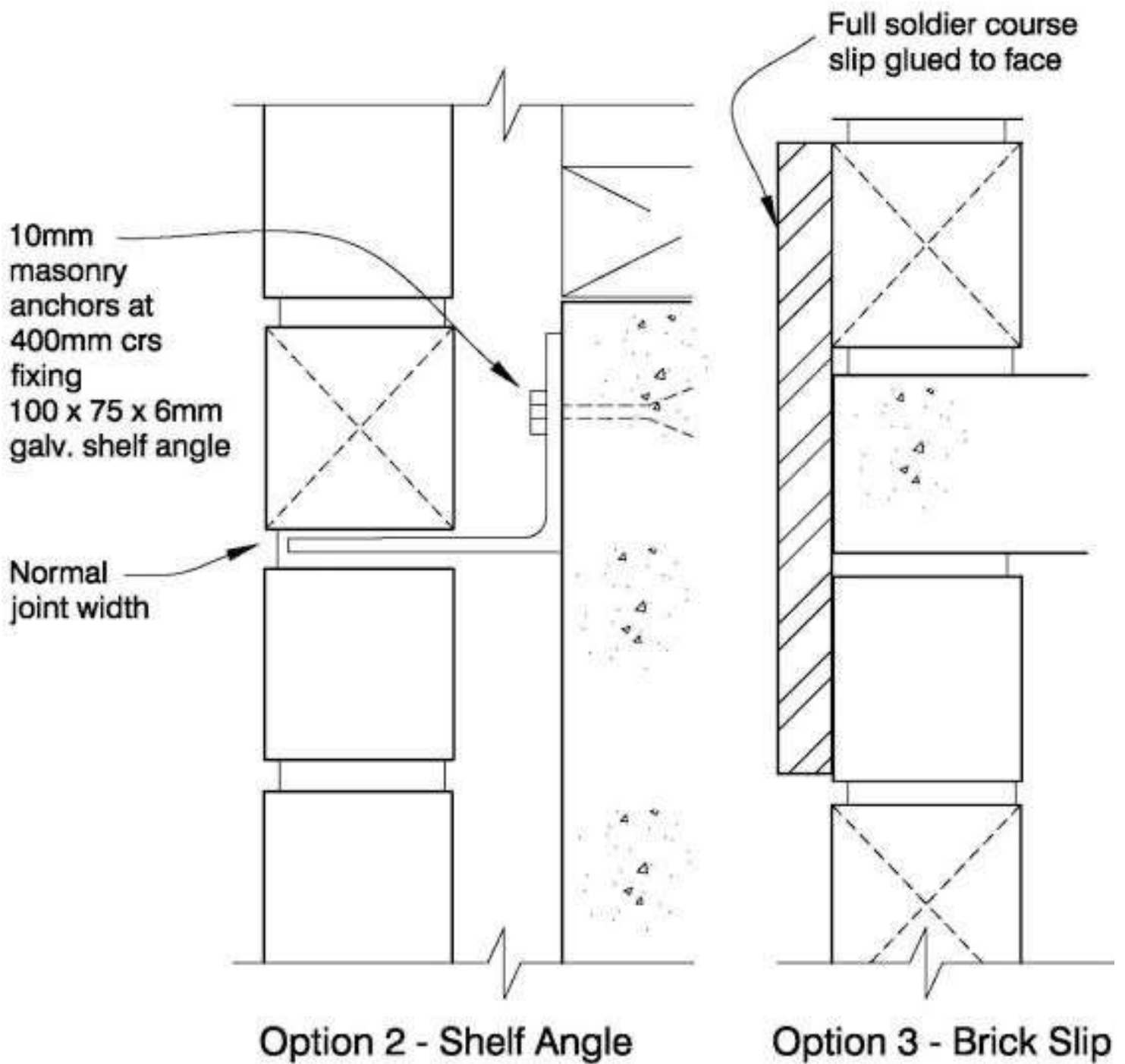


Figure 21: Hinuera Natural Stone  
Lintel Fixture – Mid Floor

# Appendix 5: Drawings

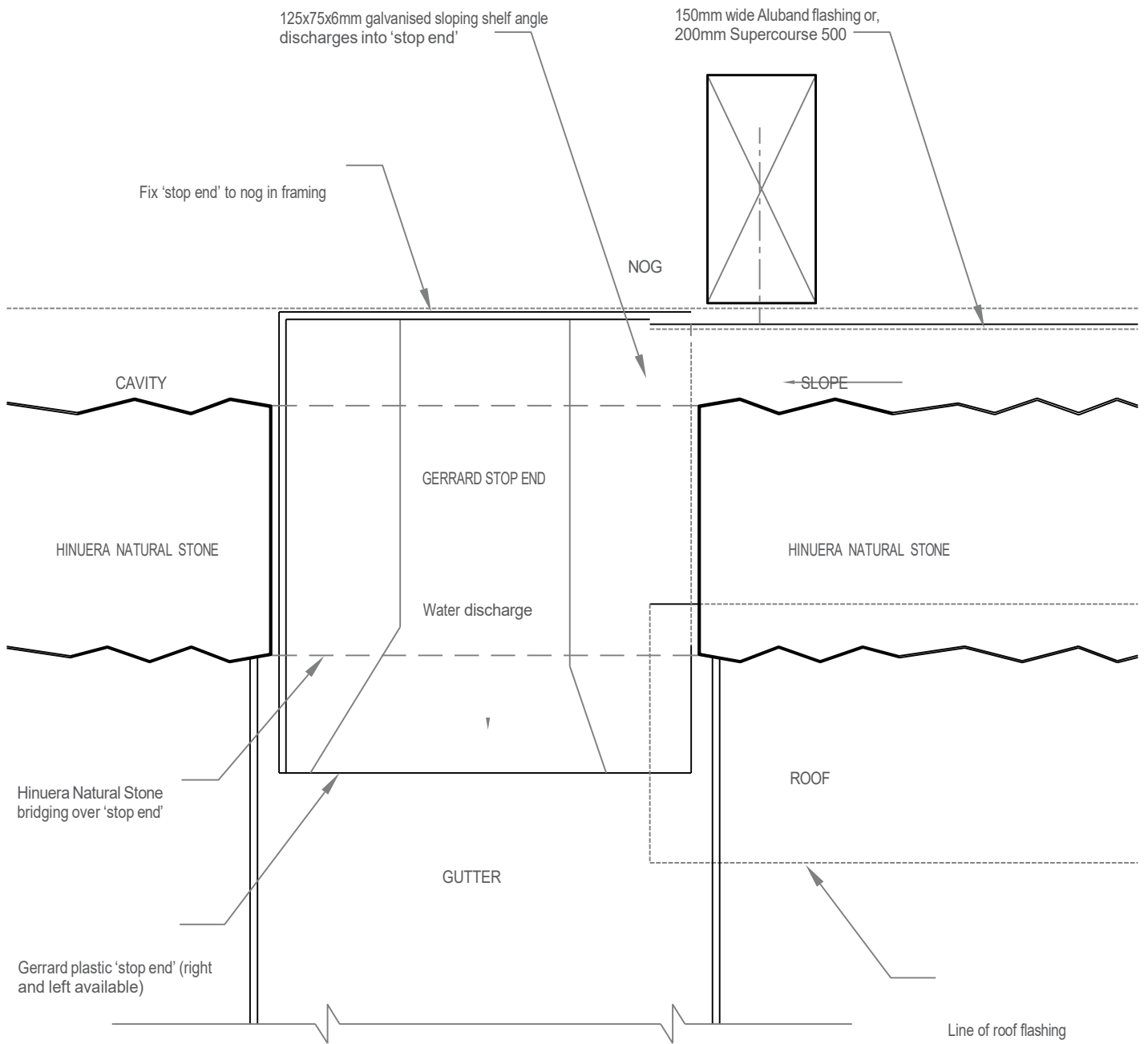


Figure 22: **Base of sloping shelf angle, plan view gutter/wall junction**



**Lifetime Promotions Ltd**  
trading as Lifetime Building Consultants

John Oliver  
Building Consultant

25 July 2015  
John Simpson  
Technical Manager  
Hinuera Natural Stone  
P.O.Box 89  
Matamata 3440

Dear John,

**HINUERA NATURAL STONE – INSTALLATION SPECIFICATION  
PRODUCER STATEMENT DESIGN (PS1) – SPECIFIC DESIGN  
Incorporates Alternative Solutions**

This Producer Statement for Hinuera Natural Stone masonry veneer products is conditional upon all the requirements outlined in the product specification information, 'Installation Manual', dated August 2015, being adhered to.

I believe on reasonable grounds, that any building clad using Hinuera Natural Stone masonry products, to this specification, will comply with the relevant provisions of the Building Code, and in particular B1, B2 and E2.

The Design Firm issuing this statement, Lifetime Promotions Ltd, holds a current policy of Professional Indemnity Insurance no less than \$200,000. I understand that this producer statement, if accepted, will be relied on by the BCA, for the purposes of establishing compliance with the Building Code.

Regards,



John Oliver  
Building Consultant  
Specialist Building Consultant in Brick Veneer  
Author of John Oliver's BRICK BOOK  
Member of BOINZ

Tel	00 64 9 624 4045	PO Box 17-220,
Mob	021 84 85 86	Greenlane, Auckland
Fax	00 64 9 624 4046	Email lifetimepromotions@xtra.co.nz

GST No. 73-670-292

## Appendix 7: Order form sample



Hinuera Natural Stone Quarry  
 State Highway 29  
 PO Box 89, Matamata

Phone: 07 888 1843  
 Fax: 07 888 1930

Attention:

Product	Description				
Sawnstone small 270x130mm	Sawn Natural	90 Series		70 Series	
	Rumbled Natural	90 Series		70 Series	
	Sawn Golden Haze	90 Series		70 Series	
	Rumbled Golden Haze	90 Series		70 Series	
	Sawn Kiln Golden Haze	90 Series		70 Series	
	Rumbled Golden Haze	90 Series		70 Series	
	Note: Sawnstone small = Ahi stone only				
Sawnstone medium 390x190		90 Series		70 Series	
		Ahi		Awa	
		Natural		Golden Haze	
Splitstone	Height:	200mm		150mm	
		130mm			
	Stone:	2 size		3 size	
	Length:	Ahi		Awa	
	Type:	Random		Cut to length	
Sawnstone	Stone:	Natural		Golden Haze	
	Type:	Ahi		Awa	
	Size:	Natural		Golden Haze	
	Other specify:	200mm Random		600x300x90	
Paving	Stone:	Ahi		Awa Select	
	Type:	Natural		Golden Haze	
	Size:	380x380x20mm		770x380x20mm	
		500x500x20mm		600x600x20mm	

Customer signature:

Date:

### Delivery

Hinuera Natural Stone products are made to order. However a few standard product lines may be held in stock from time to time. Manufacturing lead times may vary and therefore it is important delivery date requirements are clarified at the time of placing an order.

Any periods or times indicated are agreed estimates and while HNS Ltd will make reasonable endeavours to meet delivery times, HNS Ltd will have no responsibility for any loss or damage resulting from delays.

## Appendix 8: Alternative fixing method



PO Box 89  
Matamata  
Ph 07 888 1843  
Fax 07 888 1930

1 July 2022

### Installation of Hinuera Stone claddings

#### Outline

The following is a description of the recommended fixing mechanism for Hinuera Natural stone claddings to traditional timber frame and concrete masonry structures. The method incorporates a traditional masons brick tie with a stainless steel pin placed through the tie (at right angles) and embedded into the stone below the tie. The tie is embedded within the mortar in a horizontal joint in the stone cladding as prescribed in the NZS standard for masonry ties.

#### Materials (see fig 1)

Masons brick tie and tek screw, 40x3mm concrete nail with attached washer. 3mm masonry drill bit.



(fig 1)

## Appendix 8: Alternative fixing method

### Method

The tie is screwed back to the structural component as per the building code standard and aligned to the horizontal stone joint. Drill 1/3 of the hole through the tie with the masonry bit (fig 2). Place the nail through the brick tie and into the pre drilled hole (fig 3). Hammer the nail all the way into the stone (fig 4).



(fig 2)



(fig 3)



(fig 4)

**Note:** This method does not replace or override any current relevant building standards. Tie placement, spacing and frequency must comply with NZS 4210, and in conjunction with HNS Ltd technical guide (July 2022 V9).



## Appendix 9: PASS (Product Assurance Supplier Statement)



### HINUERA NATURAL STONE

#### PURPOSE

Hinuera Natural Stone is supplied for use as veneer cladding, paving, window & door sills, stair treads, fire surrounds and internal decorative linings.

#### EXPLANATION

Hinuera stone is a naturally occurring volcanic rock (Ignimbrite), quarried at Hinuera in the Waikato. It is graded into four categories based on the strength, hardness, appearance which ultimately defines its end use. It falls within the range for heavy cladding materials (refer section 1 NZS 3604).

Other processing such as cutting, kiln firing (to create different tones or highlight naturally occurring markings) or creating different surface finishes (Sawnstone and Splitstone) have no effect on the physical properties of the stone.



For further assistance please contact:

☎ 0800 446 8372

✉ [chris.cliffe@hinuera.co.nz](mailto:chris.cliffe@hinuera.co.nz)

🌐 [www.hinuera.co.nz](http://www.hinuera.co.nz)



Category	Use						Light Reflectance Value	
	Veneer cladding	Paving	Window & door sills	Stair treads	Fire surrounds	Slips	Natural	Kiln Fired
Thickness	70, 90 mm	20, 25 mm	60 mm	40, 60 mm		25, 40 mm		
Ahi	✓					✓	42.53	25.18
Kaha		✓	✓	✓	✓	✓	42.90	
Select Statuary		✓	✓	✓	✓	✓	43.68	
Awa	✓					✓	46.12	31.14

#### SCOPE AND LIMITATIONS OF USE

Scope	Limitations
<b>Location</b> In all wind zones up to and including extra high as defined in NZS 3604:2011, or up to a calculated design wind pressure of 2.5 kPa. All exposure zones as defined in NZS 3604:2011.	> In exposure zone D and where the Hinuera stone is installed externally, the stone must be coated with HYDROL DB31 Silicone Water Repellent.
<b>Building</b> In connection with a primary structure that complies with the NZ building code or where the designer and/or installer have established that the existing building is suitable for the intended building work.	> To be installed in accordance with section 9.2 E2/AS1 or over a waterproof rigid substrate where the stone may be adhered with an adhesive or be mechanically fixed. > Hinuera Stone slips must not be glued to plywood.
As an external cladding.	> To be installed over a rigid substrate where the stone may be glued with an adhesive or be mechanically fixed. > Hinuera Stone slips must not be glued to plywood. > In wet areas the rigid substrate must be impervious to moisture.
As an internal lining.	> To be installed in accordance with section 9.2 E2/AS1 or over a waterproof rigid substrate where the stone may be adhered with an adhesive or be mechanically fixed. > Hinuera Stone slips must not be glued to plywood. > In wet areas the rigid substrate must be impervious to moisture.

#### USEFUL INFORMATION

For information on the design, installation and maintenance of Hinuera Natural Stone and for our warranty refer to [www.hinuera.co.nz](http://www.hinuera.co.nz).

VERSION: V1.0

## Appendix 9: PASS (Product Assurance Supplier Statement)



### CONDITIONS OF USE

- > The Hinuera Stone must be installed by a qualified brick layer or stone mason.
- > Bagged trade mortar, using town-supply or rainwater, must be used to install the stone.

### PERFORMANCE CLAIMS

If designed, installed and maintained in accordance with all HNS Ltd requirements HNS will comply with or contribute to compliance with the following performance claims:

NZ Building Code clauses	BASIS OF COMPLIANCE <sup>1</sup>	
	Compliance statement	Demonstrated by
<b>B1 Structure</b> B1.3.1, B1.3.2, B1.3.3 (a, f, h, j, q)	ACCEPTABLE SOLUTION B1/AS1	> Meets the requirements of NZS 4210:2001 which is cited in B1/AS1.
<b>B2 Durability</b> B2.3.1 (b)	ALTERNATIVE SOLUTION	> Meets the requirements of B1/AS1. > BRANZ assessment (2005).
<b>C3 Fire affecting areas beyond the source</b> C3.4 (a) C3.7 (a)	ACCEPTABLE SOLUTION C/AS2 1 <sup>st</sup> edition, June 2019	> Ignimbrite Rock is non-combustible. > Non-combustible products have a material group number of 1.
<b>D1 Access Routes</b> D1.3.3 (d)	ACCEPTABLE SOLUTION D1/AS1	> Tested by Safety Step (NZ) Ltd to AS/NZS 4586:2004. > Achieved Mean Coefficient of Friction of 0.82.
<b>E2 External Moisture</b> E2.3.2, E2.3.5, E2.3.6, E2.3.7 (a, b, c)	ACCEPTABLE SOLUTION E2/AS1	> Hinuera Natural Stone is directly comparable to brick.
<b>F2 Hazardous Building Materials</b> F2.3.1	ACCEPTABLE SOLUTION	> Does not contain or emit harmful materials.

1. The Compliance Statement is the pass holder's statement that they have met their obligations under s14G(2) of the Building Act 2004.

5684A State Highway 29, RDI, Tirau > [chris.cliffe@hinuera.co.nz](mailto:chris.cliffe@hinuera.co.nz) > 0800 446 8372 > [www.hinuera.co.nz](http://www.hinuera.co.nz)

This Product Assurance Supplier Statement (pass™) has been prepared by TBB in accordance with MBIE PTS guidelines and the recommendations of s9.2, Determination No. 2019-011 (issued 12 April 2019). TBB is ISO9001:2016 certified. Copyright © 2017, The Building Business Limited (TBB). All rights reserved.

### SOURCES OF INFORMATION

- > aaltopaint (2020). *Light Reflectance Value evaluation*.
- > BRANZ. (2005). *DC 0980. Resistance of Hinuera Stone to Salt Attack: Stage 111 – Durability after Hydrol Sealing*.
- > Hinuera. (April 2017). *Technical Guide. Version 7*.
- > Safety Step (NZ) Ltd. (2018). *Slip Resistance Test Report*. Tested to AS/NZS 4586:2004.

2. Sources of information also include the Building Act 2004 and its regulations, including the Building Code (Schedule 1 of the Building Regulations 1992), Acceptable Solutions and Verification Methods, and relevant cited standards.

